



Second World Renewable Energy Forum:
Renewing Civilization by Renewable Energy
May, 29-31, 2004, Bonn, Germany

SOLAR POWER VILLAGE

**An integral concept to create Energy
and stable local jobs in southern rural areas**



Jürgen Kleinwächter

Ex Vice President of Complex International

1. The Problematic – the Technology

Energy is the first prerequisite for life quality, health and political stability. Today about 1,6 billion people (one fourth of the world population) has no access to electricity, 1,2 billion no access to fresh water and 2,4 billion no sanitary installations. This leads for countless humans to death and misery. Since jobs and employment are rare, more and more young people are leaving this region and often end in the slums of the large towns. This all enhances the North-South gap with disastrous consequences for the whole humanity. In its “Charta of Sounion” the Complex established already in 1961 not only technical guidelines for the development of solar technologies but also general ethical standards how to bring this technologies to the poor populations in southern countries. It is under this spirit that the concept and realisation of the SOLAR POWER VILLAGE took place.

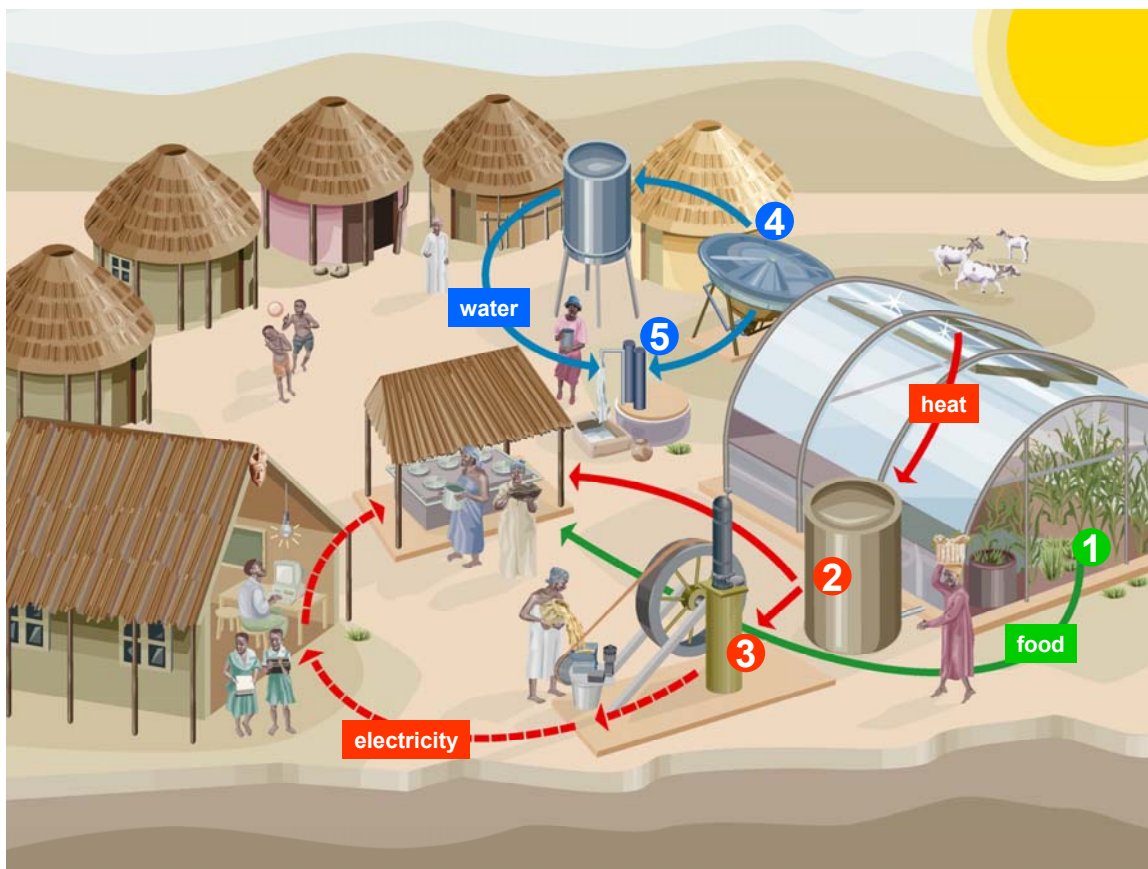

An overall artistic view of a SOLAR POWER VILLAGE

The main components are:

- (1) **The greenhouse (SolarEnvelope™)** is a light-weight structure covered with a special fluoropolymer foil. The foil is transparent for the full spectrum of the solar radiation including the UV-portion, thus no need for pesticides commonly employed in conventional greenhouses. In addition, the UV-radiation provides the aroma thus greatly improving the quality of the produce. The optical system mounted in the roof of the greenhouse concentrates the direct solar radiation onto receivers thus extracting heat from the greenhouse and protecting it from overheating; the heat generated at a high temperature level is captured in vegetable oil as the heat-carrying medium. An insulated pipe system transports the oil to a hot-oil storage tank.

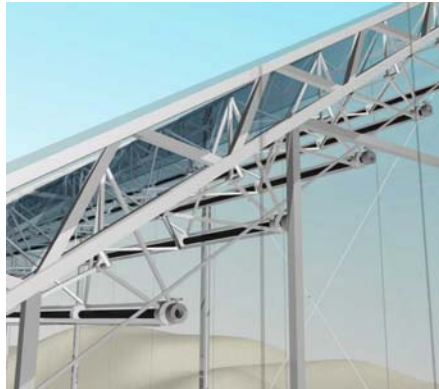



- (2) **The hot-oil storage tank** stores the hot oil at a temperature of up to 220°C. A tank with 2,000 liters of oil has the capacity to store about 75 kWh of useable heat. This saves about 500 kg wood used in energy-inefficient fire places. This energy is enough to provide 500 people with heat for cooking, to lift water from wells and to generate electricity for about 2 to 3 days. In periods of no sunshine the oil can also be heated up with biomass. The Stirling engine, the cooking stove or the system to generate hot steam for disinfection are all powered by the hot-oil storage tank.

- (3) **The middle-temperature Stirling engine** transforms thermal energy into mechanical work – and this already at temperatures of 150°C.

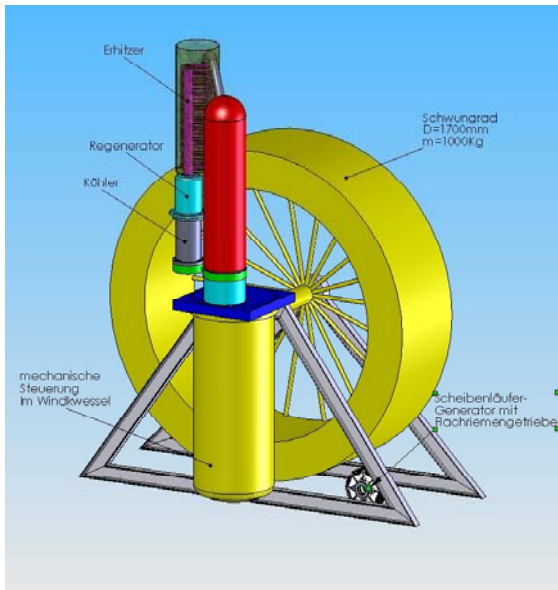

The Stirling engine provided with 50 kWh of heat energy generates electricity of about 1 kWh_e for about 10 hours. The mechanical work generated by the Stirling engine can also be used for corn milling, to pump water or for cooling.

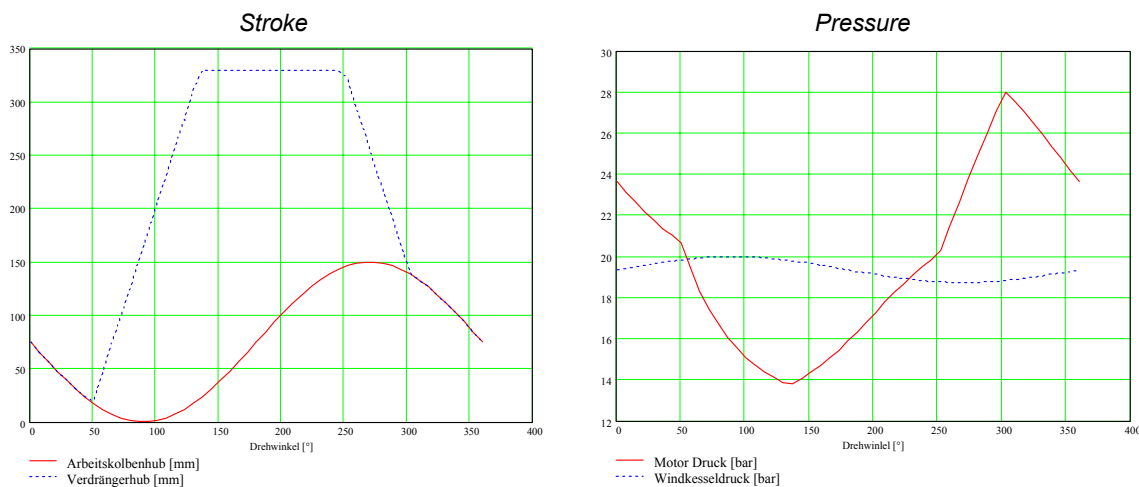

Actual measurement Sunpulse⁴⁰⁰

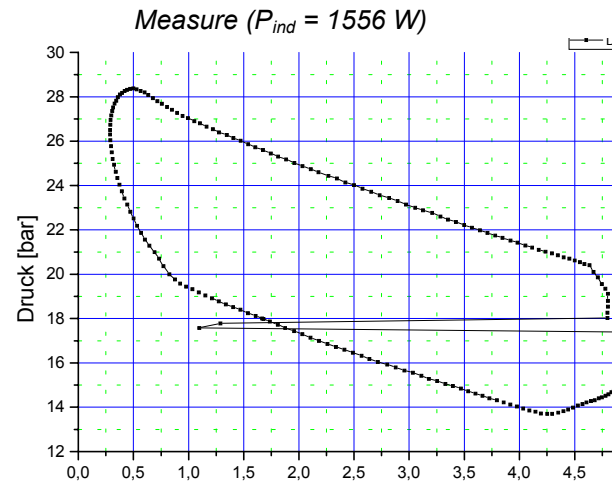
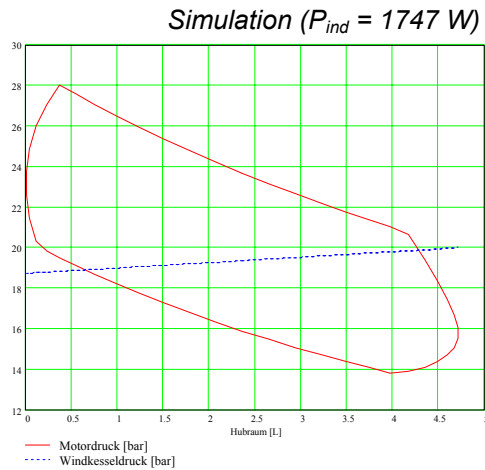

PV-Diagrams of the Sunpulse⁴⁰⁰, simulated and measured ($T_{top} = 400^\circ\text{C}$, $T_{bottom} = 50^\circ\text{C}$)

- (4) **Sunpulse™** is a low-temperature Stirling engine to pump water. It is powered by unconcentrated solar radiation and thus works independent of the hot-oil storage tank. The system pumps about 4 cbm/h water from 10m depth. Part of the pumping system is a hydraulic ram which in combination with Sunpulse can pump water from up to 60 m depth.



- (5) **The disinfection system (CleanPhoton™/UVitt™)** can be employed together or on a stand-alone basis. CleanPhoton™ disinfects water with solar radiation in combination with catalytic effective surfaces.

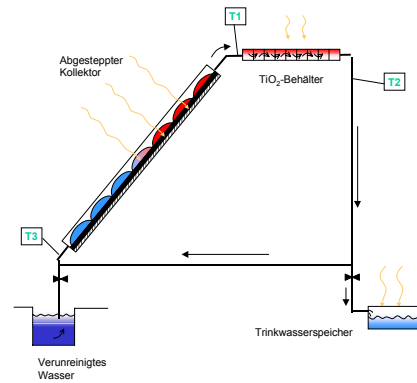

UVitt™ is powered by electricity which generates UV-radiation of high intensity for disinfection.



The SOLAR POWER VILLAGE can be expanded to include larger cooking stoves, corn-milling devices, cooling systems, steam generators, generators for AC and DC electricity, lighting/LEDs, communication equipment as well as other installations for island solutions.



Energy Flow-Chart

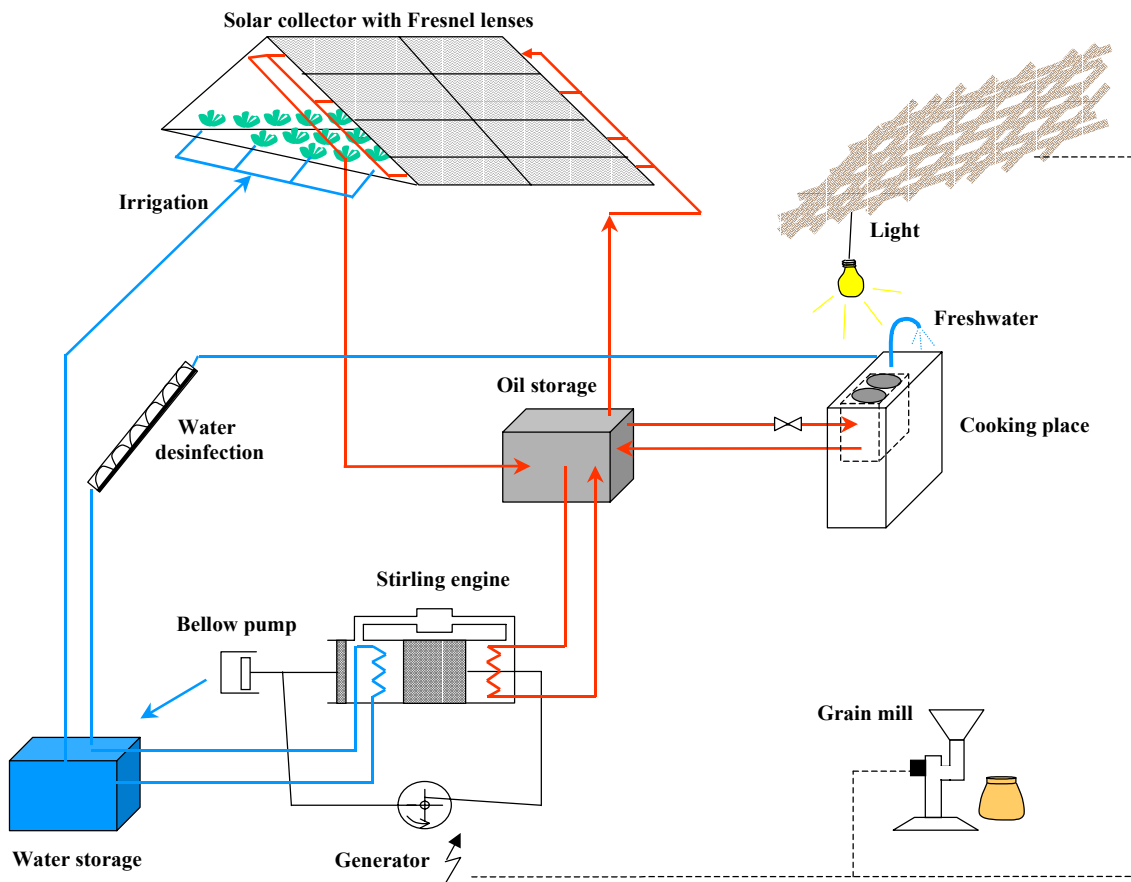

Economic Implementation

The technologies used for “Solar-Power Village” can be manufactured for the most part locally. This fosters local economic development and acquisition of technical knowledge; as a consequence the dependence from abroad is diminished. “Solar-Power Village” can be implemented as a cooperative, where the user as member pays for the services rendered – heat, water, electricity. The cooperative possesses the installation and is responsible for maintenance and funding the venture. Jobs are created in the region, the buying power of the local community is increased and a low-cost energy supply provided. The cooperative structure could be enlarged by further economic activities such as food production and distribution, so that a decentralised and independent development based on self-help is supported.

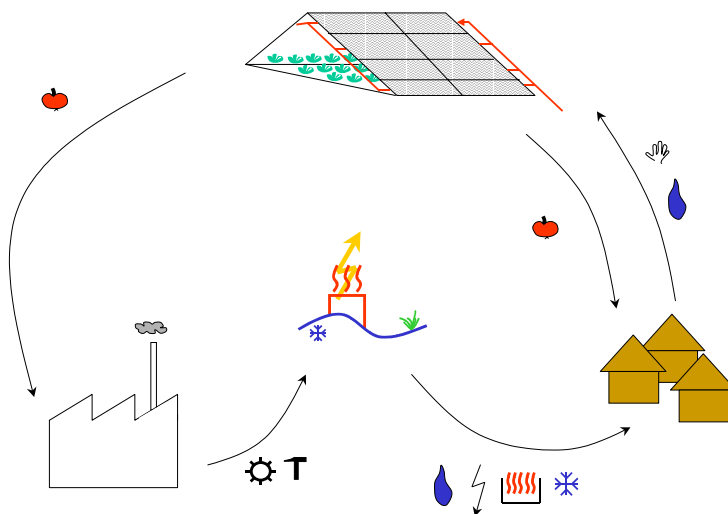

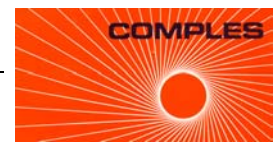

2. The idea behind it

*Whatever runs, swims, flies or crawls,
is in relation to all other creatures,
the hills, streams, valleys have a relation to the action of each man,
don't waste this richness,
respect all life and being,
if you recognize what has to be done, do it!*

(Out of the guiding theme and precept of the Cherokee Indians)

For some time mankind has established a station in space. For weeks and even months space travelers have the luck to see our world from far away and with different eyes: pictures of unbelievable beauty - our planet in a blue, green and white glimmer. From the distance the atmosphere looks like a very thin film wrapping up the earth. A thin vulnerable protective shield – nothing more. A precious and finite possession - we know this, but apparently not well enough, otherwise we would be more careful with the limited resources on earth. How else can it happen, that we ignore all the basic rules, which we accept without any discussion when we embark on manned voyages into space. For sure, the crew of the international space station IOS gets all energy needs solely from solar energy. For sure, the astronauts do not pollute the atmosphere of their spaceship by burning fossil fuels openly. And for sure, they economize their reserves efficiently, so there is always enough energy available on board. Maybe this sensible use of energy has a trivial background: In space there do not exist any resources, which can be taken from neighbors enforcing the right of the more powerful and the one who was wasteful.

What is the state of our blue planet?

A recent Pentagon(!)-study talks about dangers never imagined: The worldwide climate change expected to occur in the near future may possibly lead to wars, this time for food and water and to the migration of whole populations! An international group of botanists and zoologists forecasted in January 2004, that 15 to 35% of the species will die out until the year 2050, the scientific magazine „Science“ expects the world population to grow over the next years to 8 – 10 billion people – with all the dire consequences of exploiting the world resources even more. Among the essential things for mankind to survive on this planet – health, water, food, energy, air quality and a great variety of species, there is not one which from a global viewpoint is not in a critical condition.

This is the context in which Sunvention has to be seen – and our motivation:

Access for everybody to energy and a clean and healthy environment is the key, which determines our future welfare. Therefore we are working on the idea of a solar future for all regions of the world assessable. We seek a new model, a new paradigm. We are running out of time to bring economics and ecology in sync. Technologies to harness the abundant solar energy for mankind do already exist; though powerful factions and pressure groups want to make us believe that environment-friendly solar technologies are expensive and uneconomical and that they can only be implemented in small doses.



They go even further: one should abandon this completely in times of economical crisis – this environment friendly and “expensive” technology cannot be paid for and jobs have priority. How wrong! Environmental and solar technologies have created already plenty of stable jobs in industrial countries. Only the nations of the South have not yet had the chance to participate in the evolution of the solar industry. Consequently - how absurd – desperate emigrants, who do not find work and food in the country migrate to the ever expanding slums in large cities. Migration is going global: Impoverished people struggle to take refuge in industrial countries which in turn use desperately and at high costs defensive measures and enforce deportation. This causes individual tragedies and desperation and in its final deplorable consequence a seed for global terrorism.

It is here that Sunvention with its SOLAR POWER VILLAGE is coming in.

In decades of research and development solar-based systems have been developed simple in technology, which can be manufactured with resources and manufacturing facilities available locally and, most importantly, which create jobs in the local economy. They are efficient and meet all the energy needs of a community round-the-clock: for cultivating agricultural produce, to pump water, to generate heat for cooking, to do mechanical work and to generate electricity. SOLAR POWER VILLAGE is ideally suited for a technology transfer between North and South. In this there will be only winners since both are benefiting from the exchange of their respective know-know. This process will contribute to justice, peace, life quality, unfolding of creativity and fulfillment.

3. Technological Status, Organisational Form

The core components of the SOLAR POWER VILLAGE have been developed during the last decade by BSR Solar Technologies and partners. At the time being a fully functional demonstration prototype of the SOLAR POWER VILLAGE is operating on the testground of BSR Solar Technologies in Lörrach, Germany.

A new company – “SUNVENTION” was created with the target to built up international partnerships to implement the SOLAR POWER VILLAGE technology on a world wide basis.

These are the guiding lines of

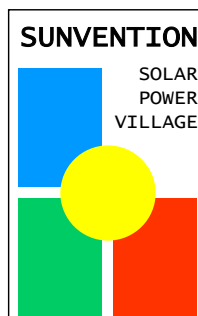

SUNVENTION believes that changes are absolutely necessary. As a catalyst Sunvention offers a platform to draw together different experiences and know-how in the pursuit of a common objective. Sunvention is an open system, the hub of an energetic network. Sunvention welcomes organizations, companies and persons to take up and to promote the mission and to get involved in its realization. Our partners can accompany projects on a part-time or permanent basis – or just be advised how to employ SOLAR POWER VILLAGE or components thereof.

Sunvention’s logo stands for the mission: everything circulates around the yellow circle, the sun. It is the sun which supplies the basic resources to live: water (blue), food (green) and energy (red).

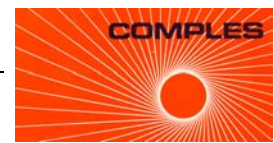

Jointly with partners and sponsors the creative and highly motivated team of Sunvention seeks to achieve the break-through for solar-based distributed power generation. This is our basic claim expressed in our strategic objectives and business policies:

- reduce the dependence on fossil energies
- slow down the exploitation of limited resources, deforestation,
- stop the conversion of large areas into deserts and global climate warming
- provide help for self-help to people in need of clean water, energy and food
- support local economies to make health, prosperity and education attainable in all regions
- and, at the same time, preserve ethnic and ecological values
- carry the ideas of Sunvention beyond developing countries to the developed world
- top employ profits generated for making the mission independent and sustainable.

The products of SOLAR POWER VILLAGE are based on innovative solar technologies developed by BSR SOLAR TECHNOLOGIES and made available to Sunvention. BSR SOLAR TECHNOLOGIES brings in experience and accomplishments achieved over the last 20 years which are specifically focused on solving the energy needs in sun-belt countries. Sunvention started its operations in the spring of 2004 and commenced with the implementation of its business strategy: to provide sustainable and self-sufficient solar energy systems which never have been realized before

- In Lörrach, Germany, the base of BSR SOLAR TECHNOLOGIES, the first demonstration system has been realized and it is open to all interested people: SOLAR POWER VILLAGE is not just utopia, it is real and doable.
- During the “World Conference of Renewable Energies” in Bonn the concept and the realization of the SOLAR POWER VILLAGE has been discussed and evaluated very positively.
- Building up demonstration villages with test operation and training
- Developing serial production
- Winning partners for technology transfer
- Initiating local production and operation of SOLAR POWER VILLAGE
- Taking an active role in emission trading
- Acquiring grants