

COMANCHE PEAK STEAM ELECTRIC STATION
OFFSITE DOSE CALCULATION MANUAL
UNIT 1 AND UNIT 2

TABLE OF CONTENTS

<u>Number/Title</u>	<u>Page</u>
List of Tables	v
List of Figures	vi
Cross-Reference to Technical Specifications and REC	vii
References	x
Introduction	xi
PART I - RADIOLOGICAL EFFLUENT CONTROLS	
SECTION 1.0 - USE AND APPLICATIONS	I 1-0
SECTION 1.1 - DEFINITIONS	I 1-1
SECTION 2.0 - NOT USED	I 2-0
SECTIONS 3.0 AND 4.0 - CONTROLS AND SURVEILLANCE REQUIREMENTS	I 3/4-0
3/4.0 - Applicability	I 3/4-1
3/4.3.3.4 - Radioactive Liquid Effluent Monitoring Instrumentation	I 3/4-2
3/4.3.3.5 - Radioactive Gaseous Effluent Monitoring Instrumentation	I 3/4-8
3/4.3.3.6 - Meteorological Monitoring Instrumentation	I 3/4-14
3/4.7.15 - Sealed Source Contamination	I 3/4-16
3/4.11.1 - Liquid Effluents	I 3/4-18
3/4.11.1.1 - Concentration Controls	I 3/4-18
3/4.11.1.2 - Dose	I 3/4-23
3/4.11.1.3 - Liquid Radwaste Treatment System	I 3/4-24
3/4.11.1.4 - LVW Pond Resin Inventory	I 3/4-25
3/4.11.2 - Gaseous Effluents	I 3/4-27
3/4.11.2.1 - Dose Rate	I 3/4-27
3/4.11.2.2 - Dose - Noble Gases	I 3/4-31
3/4.11.2.3 - Dose - Iodine-131, Iodine-133, Tritium, and Radioactive Material in Particulate Form	I 3/4-32
3/4.11.2.4 - Gaseous Radwaste Treatment System	I 3/4-33
3/4.11.4 - Total Dose	I 3/4-34
3/4.12.1 - Radiological Environmental Monitoring Program	I 3/4-35

TABLE OF CONTENTS
(continued)

<u>Number/Title</u>	<u>Page</u>
3/4.12.2 - Land Use Census	I 3/4-46
3/4.12.3 - Interlaboratory Comparison Program	I 3/4-47
BASES	I B 3/4-0
SECTION 5.0 - DESIGN FEATURES	I 5-0
5.1.3 - Map Defining Controlled Areas, Unrestricted Areas and Site Boundary for Radioactive Gaseous and Liquid Effluents	I 5-1
SECTION 6.0 - ADMINISTRATIVE CONTROLS	I 6-0
6.9.1.3 - Annual Radiological Environmental Operating Report	I 6-1
6.9.1.4 - Radioactive Effluent Release Report	I 6-2
6.14 - Offsite Dose Calculation Manual (ODCM)	I 6-3
PART II - CALCULATIONAL METHODOLOGIES	
1.0 LIQUID EFFLUENTS	II 1-1
1.1 10CFR20 and Radiological Effluent Control	II 1-1
3/4.11.1.1 Compliance	
1.1.1 Isotopic Concentration of the Waste Tank	II 1-2
1.1.2 Effluent Flow Rate (f)	II 1-2
1.1.3 Dilution of Liquid Effluents	II 1-3
1.1.4 Actual Dilution Factor (ADF)	II 1-4
1.1.5 Required Dilution Factor (RDF)	II 1-4
1.1.6 10CFR20 Compliance	II 1-5
1.2 Radiation Monitor Alarm Setpoints	II 1-5
1.2.1 Primary Liquid Effluent Monitor (XRE-5253)	II 1-5
1.2.2 Turbine Building Sump Effluent Radiation Monitors (1RE-5100 and 2RE-5100)	II 1-6
1.2.3 Station Service Water Effluent Radiation Monitors (1RE-4269/4270 and 2RE-4269/4270)	II 1-7

TABLE OF CONTENTS
(continued)

<u>Number/Title</u>	<u>Page</u>
1.2.4 Auxiliary Building to LVW Pond Radiation Monitor (XRE-5251A)	II 1-8
1.3 Dose Calculations for Liquid Effluents	II 1-8
1.3.1 Calculation of Dose Due to Liquid Releases	II 1-9
1.3.2 Calculation of Dose Due to Radionuclide Buildup in the Lake	II 1-10
1.4 Dose Projections for Liquid Effluents	II 1-12
1.5 Definitions of Common Liquid Effluent Parameters	II 1-12
2.0 GASEOUS EFFLUENTS	II 2-1
2.1 Radiological Effluent Control 3/4.11.2.1 Compliance	II 2-2
2.1.1 Dose Rates Due to Noble Gases	II 2-2
2.1.2 Dose Rates Due to Radioiodines, Tritium, and Particulates	II 2-4
2.2 Gaseous Effluent Monitor Setpoints	II 2-4
2.2.1 Plant Vent Effluent Release Rate Monitors (XRE-5570A/XRE-5570B) Effluent Release Rate Channels	II 2-5
2.2.2 Plant Vent Stack Noble Gas Activity Monitors (XRE-5570A/XRE-5570B and XRE-5567A/XRE-5567B)	II 2-6
2.2.3 Sampler Flow Rate Monitors (X-RFT-5570A-1/X-RFT-5570B-1)	II 2-6
2.2.4 Auxiliary Building Ventilation Exhaust Monitor (XRE-5701)	II 2-6
2.2.5 Containment Atmosphere Gaseous Monitors (1RE-5503/2RE-5503)	II 2-7
2.3 Dose Calculations for Gaseous Effluents	II 2-8
2.3.1 Dose Due to Noble Gases	II 2-8
2.3.2 Dose Due to Radioiodines, Tritium, and Particulates	II 2-9
2.4 Dose Projections for Gaseous Effluents	II 2-11
2.5 Dose Calculations to Support Other Requirements	II 2-11

TABLE OF CONTENTS
(continued)

<u>Number/Title</u>	<u>Page</u>
2.6 Meteorological Model	II 2-12
2.6.1 Dispersion Calculations	II 2-12
2.6.2 Deposition Calculations	II 2-14
2.7 Definitions of Gaseous Effluents Parameters	II 2-14
3.0 RADIOLOGICAL ENVIRONMENTAL MONITORING	II 3-1
3.1 Sampling Locations	II 3-1
3.2 Interlaboratory Comparison Program	II 3-1
<u>APPENDICES</u>	
A. Pathway Dose Rate Parameter	A-1
B. Inhalation Pathway Dose Factor	B-1
C. Ground Plane Pathway Dose Factor	C-1
D. Grass-Cow-Milk Pathway Dose Factor	D-1
E. Cow-Meat Pathway Dose Factor	E-1
F. Vegetation Pathway Dose Factor	F-1
G. Supplemental Guidance Statements - Deleted	G-1

TABLE OF CONTENTS

LIST OF TABLES

<u>Table No.</u>	<u>Title</u>	<u>Page</u>
<u>PART I - RADIOLOGICAL EFFLUENT CONTROLS</u>		
1.1	ODCM Frequency Notation	I 1-4
1.2	Deleted.	I 1-5
3.3-7	Radioactive Liquid Effluent Monitoring Instrumentation	I 3/4-3
4.3-3	Radioactive Liquid Effluent Monitoring Instrumentation Surveillance Requirements	I 3/4-6
3.3-8	Radioactive Gaseous Effluent Monitoring Instrumentation	I 3/4-9
4.3-4	Radioactive Gaseous Effluent Monitoring Instrumentation Surveillance Requirements	I 3/4-12
3.3-9	Meteorological Monitoring Instrumentation	I 3/4-15
4.11-1	Radioactive Liquid Waste Sampling And Analysis Program	I 3/4-19
4.11-2	Radioactive Gaseous Waste Sampling and Analysis Program	I 3/4-28
3.12-1	Radiological Environmental Monitoring Program	I 3/4-37
3.12-2	Reporting Levels for Radioactivity Concentrations in Environmental Samples	I 3/4-43
4.12-1	Detection Capabilities For Environmental Sample Analysis LLDs	I 3/4-44
<u>PART II - CALCULATIONAL METHODOLOGIES</u>		
1.1	Summary of Liquid Release Pathways	II 1-15
1.2	Site Related Ingestion Dose Commitment Factor Air	II 1-16
2.1	Summary of Gaseous Release Pathways	II 2-18
2.2	Dose Factors for Exposure to a Semi-Infinite Cloud of Noble Gases	II 2-19
2.3	Pathway Dose Rate Parameter (Pi)	II 2-20
2.4	Pathway Dose Factors	II 2-21
2.5	Controlling Receptor Pathways and Locations, and Atmospheric Dispersion Parameters (for Dose Calculations Required by Radiological Effluent Control 3/4.11.2.3)	II 2-42
3.1	Environmental Sampling Locations	II 3-2

TABLE OF CONTENTS

LIST OF FIGURES

<u>Figure</u>	<u>Title</u>	<u>Page</u>
<u>PART I - RADIOLOGICAL EFFLUENT CONTROLS</u>		
5.1-3	Controlled Area, Unrestricted Area and Site Boundary for Radioactive Gaseous and Liquid Effluents	I 5-2
<u>PART II - CALCULATIONAL METHODOLOGIES</u>		
1.1	Liquid Effluent Discharge Pathways	II 1-20
1.2	Circulating Water Pump Curves	II 1-21
1.3	Energy Response to Gamma Radiations for RD-33 Type Detector	II 1-22
2.1	Gaseous Waste Processing System	II 2-43
2.2	Plume Depletion Effect for Ground-Level Releases	II 2-44
2.3	Vertical Standard Deviation of Material in a Plume	II 2-45
2.4	Relative Deposition for Ground-Level Releases	II 2-46
2.5	Open Terrain Correction Factor	II 2-47
3.1	Radiological Environmental Monitoring Locations	II 3-3

CROSS-REFERENCE TO TECHNICAL SPECIFICATIONS AND REC

Document	Number or Section	Requirement	ODCM Section
<u>PART I-RADIOLOGICAL EFFLUENT CONTROLS (REC)</u>			
Tech Spec	4.1	Site Location/Map	5.1.3 and Fig. 5.1-3
Tech Spec	5.5.1	Offsite Dose Calculation Manual (ODCM)	6.14
Tech Spec	5.5.4.a	Effluent monitoring instrumentation operability, surveillance, and setpoint requirements	3/4.3.3.4 and 3/4.3.3.5
Tech Spec	5.5.4.b	Limit liquid effluent concentration	3/4.11.1.1
Tech Spec	5.5.4.c	Effluent monitoring, sampling, and analysis requirements	3/4.11.1.1 and 3/4.11.2.1
Tech Spec	5.5.4.d	Limit doses due to liquid effluents	3/4.11.1.2
Tech Spec	5.5.4.e	Determine cumulative and projected doses due to radioactive effluents	3/4.11.1.2, 3/4.11.2.2, 3/4.11.2.3, 3/4.11.1.3 and 3/4.11.2.4
Tech Spec	5.5.4.f	Effluent treatment systems operability requirements	3/4.11.1.3 and 3/4.11.2.4
Tech Spec	5.5.4.g	Limit gaseous effluent dose rate	3/4.11.2.1
Tech Spec	5.5.4.h	Limit noble gas air dose	3/4.11.2.2
Tech Spec	5.5.4.i	Limit gaseous effluent iodine and particulate dose	3/4.11.2.3
Tech Spec	5.5.4.j	Limit total dose	3/4.11.4
Tech Spec	5.6.2	Annual Radiological Environmental Operating Report	6.9.1.3
Tech Spec	5.6.3	Radioactive Effluent Release Report	6.9.1.4
<u>PART II - CALCULATIONAL METHODOLOGIES</u>			
REC	3/4.11.1.1	Liquid effluent concentration	1.1
REC	3/4.11.1.2	Dose due to liquid effluents	1.3

CROSS-REFERENCE TO TECHNICAL SPECIFICATIONS AND REC
(continued)

Document	Number or Section	Requirement	ODCM Section
REC	3/4.11.1.3	Dose projections for liquid releases	1.4
REC	3/4.11.2.1.a	Dose rate due to noble gases	2.1.1
REC	3/4.11.2.1.b	Dose rate due to iodine, tritium, and particulates with half-lives greater than eight days	2.1.2
REC	3/4.11.2.2	Air dose due to noble gases	2.3.1
REC	3/4.11.2.3	Doses due to iodine, tritium, and particulates with half-lives greater than eight days	2.3.2
REC	3/4.11.2.4	Dose projections for gaseous releases	2.4
REC	3/4.11.4	Total dose due to releases of radioactivity and direct radiation	2.5
REC	3/4.12.1	Description of radiological environmental sampling locations	3.1
REC	3/4.12.2	Dose calculations for identifying changes to environmental sampling locations	2.5
REC	3/4.12.3	Description of the Interlaboratory Comparison Program	3.2
REC	3.3.3.4	Radioactive liquid effluent monitoring channels alarm/trip setpoints	
		• liquid waste monitor (XRE-5253)	1.2.1
		• turbine building sump monitors (1RE-5100 and 2RE-5100)	1.2.2
		• service water monitors (1RE-4269/4270 and 2RE-4269/4270)	1.2.3
		• auxiliary building to LVW Pond radiation monitor (XRE-5251A)	1.2.4

CROSS-REFERENCE TO TECHNICAL SPECIFICATIONS AND REC
(continued)

Document	Number or Section	Requirement	ODCM Section
REC	3.3.3.5	Radioactive gaseous effluent monitoring channels alarm/trip setpoints	
		<ul style="list-style-type: none"> • noble gas release rate monitors XRE-5570A and XRE-5570B (WGRM release rate channels) 2.2.1 • noble gas activity monitors XRE-5570A and XRE-5570B (WRGM low range activity channel) XRE-5567A and XRE-5567B (noble gas channel) 2.2.2 • waste gas holdup system monitor (auxiliary building vent monitor) XRE-5701 2.2.4 • sampler flow rate monitor XFT-5570A2/B2 2.2.3 	
Tech Spec	3.3.6	Radiation monitoring channels alarm/trip setpoint	
		<ul style="list-style-type: none"> • Containment atmosphere gaseous monitors (containment vent monitors) 1RE-5503 and 2RE-5503 2.2.5 	
Tech Spec REC	5.6.3 6.9.1.4	Assessment of radiation doses due to liquid and gaseous effluents released during the previous year	2.5
Tech Spec REC	5.6.3 6.9.1.4	Assessment of doses to members of the public inside the site boundary	2.5
Tech Spec REC	5.6.3 6.9.1.4	Assessment of doses to the most likely exposed member of the public from reactor releases and direct radiation	2.5

REFERENCES

1. Boegli, J.S., R. R. Bellamy, W. L. Britz, and R. L. Waterfield, "Preparation of Radiological Effluent Technical Specifications for Nuclear Power Plants," NUREG-0133 (October 1978).
2. Calculation of Annual Doses to Man from Routine Releases of Reactor Effluents for the Purpose of Evaluating Compliance with 10CFR Part 50, Appendix I, U. S. NRC Regulatory Guide 1.109, Rev. 1 (October 1977).
3. "Environmental Report," TU Electric, Comanche Peak Steam Electric Station.
4. "Final Safety Analysis Report," TU Electric, Comanche Peak Steam Electric Station.
5. Methods for Estimating Atmospheric Transport and Dispersion of Gaseous Effluents in Routine Releases from Light-Water-Cooled Reactors, U.S. NRC Regulatory Guide 1.111 (March 1976).
6. Methods for Estimating Atmospheric Transport and Dispersion of Gaseous Effluents in Routine Release from Light-Water-Cooled Reactors, U.S. NRC Regulatory Guide 1.111, Rev. 1 (July 1977).
7. Meteorology and Atomic Energy; Edited by Slade, D. H.; U. S. Department of Commerce (July 1968).
8. "Technical Specifications," TU Electric, Comanche Peak Steam Electric Station.
9. Implementation of Programmatic Controls for Radiological Effluent Technical Specifications in the Administrative Controls Section of the Technical Specifications and the Relocation of Procedural Details of RETS to the Offsite Dose Calculation Manual or to the Process Control Program (Generic Letter 89-01), USNRC, January 31, 1989.
10. CPSES Technical Evaluation No. RP-90-3077, "Calculation of Site Related Ingestion Dose Commitment Factors For Sb-122."
11. "Calculation of Annual Doses to Man from Routine Releases of Reactor Effluents for the Purpose of Evaluating Compliance with 10 CFR Part 50, Appendix I," USNRC Regulatory Guide 1.109 (March 1976).
12. Code of Federal Regulation, Title 10, Parts 20 and 50.

INTRODUCTION

The OFFSITE DOSE CALCULATION MANUAL (ODCM) is a supporting document of the CPSES Technical Specifications. Part I of the ODCM contains (1) the Radioactive Effluent Controls required by Technical Specification 5.5.4, (2) descriptions of the information that should be included in the Annual Radiological Environmental Operating and Radioactive Effluent Release Reports required by Technical Specifications 5.6.2 and 5.6.3, (3) Controls for Meteorological Monitoring Instrumentation and Sealed Source Leakage, and (4) Radiological Environmental Monitoring Controls. Part II of the ODCM describes the methodology and parameters to be used in the calculation of offsite doses due to radioactive liquid and gaseous effluents and in the calculation of liquid and gaseous effluent monitoring instrumentation alarm/trip setpoints. Liquid and Gaseous Radwaste Treatment System configurations are shown in Part II, Figures 1.1 and 2.1.

The ODCM is maintained for use as a reference guide and training document on accepted methodologies and calculations. Changes in the calculation methods or parameters will be incorporated into the ODCM in order to assure that the ODCM represents the present methodology in all applicable areas. TXU Power initiated changes to the ODCM will be implemented in accordance with Section 5.5.1 of the Technical Specifications.

The ODCM follows the methodology and models suggested by NUREG-0133 (Ref. 1) and Regulatory Guide 1.109, Revision 1 (Ref. 2). Simplifying assumptions have been applied in this manual where applicable to provide a more workable document for implementing the Radiological Effluent Control requirements. This simplified approach will result in a more conservative dose evaluation, but requires the least amount of time for establishing compliance with regulatory requirements.

This manual is designed to provide necessary information in order to simplify the dose calculations. The dose calculations can be optionally expanded to several levels of effort. The complexity of the dose calculations can be expanded by several levels of effort, aiming toward a full calculation in accordance with Regulatory Guide 1.109. Future changes to the ODCM may be initiated to implement more complex calculations as systems become available and are validated that can reliably, economically and properly perform these more complex calculations. A beneficial approach to implementing the Radiological Effluent Control Program and Regulatory Guide 1.21 (Radioactive Effluent Release Report) requirements is to use a computerized system to determine the effluent releases and update cumulative doses.

PART I
RADIOLOGICAL EFFLUENT CONTROLS

SECTION 1.0
USE AND APPLICATIONS

1.0 USE AND APPLICATIONS

1.1 DEFINITIONS

The defined terms of this section appear in capitalized type and are applicable throughout these Controls.

ACTION

ACTION shall be that part of a Control that prescribes required actions to be taken under designated conditions within specified completion times.

ANALOG CHANNEL OPERATIONAL TEST

An ANALOG CHANNEL OPERATIONAL TEST shall be the injection of a simulated signal into the channel as close to the sensor as practicable to verify OPERABILITY of alarm, interlock and/or trip functions. The ANALOG CHANNEL OPERATIONAL TEST shall include adjustments, as necessary, of the alarm, interlock and/or Trip Setpoints such that the setpoints are within the required range and accuracy.

CHANNEL CALIBRATION

A CHANNEL CALIBRATION shall be the adjustment, as necessary, of the channel output such that it responds within the necessary range and accuracy to known values of the parameter that the channel monitors. The CHANNEL CALIBRATION shall encompass all devices in the channel required for channel OPERABILITY. Calibration of instrument channels with resistance temperature detector (RTD) or thermocouple sensors may consist of an inplace qualitative assessment of sensor behavior and normal calibration of the remaining adjustable devices in the channel. The CHANNEL CALIBRATION may be performed by means of any series of sequential, overlapping or total channel steps.

CHANNEL CHECK

A CHANNEL CHECK shall be the qualitative assessment of channel behavior during operation by observation. This determination shall include, where possible, comparison of the channel indication and/or status with other indications and/or status derived from independent instrument channels measuring the same parameter.

DIGITAL CHANNEL OPERATIONAL TEST

A DIGITAL CHANNEL OPERATIONAL TEST shall consist of exercising the digital computer hardware using data base manipulation and injecting simulated process data to verify OPERABILITY of alarm and/or trip functions.

DOSE EQUIVALENT I-131

DOSE EQUIVALENT I-131 shall be that concentration of I-131 (microCurie/gram) which alone would produce the same thyroid dose as the quantity and isotopic mixture of I-131, I-132, I-133, I-134, and I-135 actually present. The thyroid dose conversion factors used for this calculation shall be those listed in Table III of TID-14844, "Calculation of Distance Factors for Power and Test Reactor Sites" or Table E-7 of NRC Regulatory Guide 1.109, Revision 1, October 1977.

DEFINITIONS

FREQUENCY NOTATION

The FREQUENCY NOTATION specified for the performance of Surveillance Requirements shall correspond to the intervals defined in Table 1.1.

MEMBER(S) OF THE PUBLIC

MEMBER(S) OF THE PUBLIC means an individual in a CONTROLLED or UNRESTRICTED AREA. However, an individual is not a MEMBER OF THE PUBLIC during any period in which the individual receives an occupational dose.

OFFSITE DOSE CALCULATION MANUAL

The OFFSITE DOSE CALCULATION MANUAL (ODCM) shall contain the methodology and parameters used in the calculation of offsite doses resulting from radioactive gaseous and liquid effluents, calculation of gaseous and liquid effluent monitoring Alarm/Trip Setpoints, and conduct of the Environmental Radiological Monitoring Program. The ODCM shall also contain (1) the Radioactive Effluent Controls and Radiological Environmental Monitoring Programs required by Technical Specification Section 5.5.4 and (2) descriptions of the information that should be included in the Annual Radiological Environmental Operating and Radioactive Effluent Release Reports required by Technical Specifications 5.6.2 and 5.6.3, respectively.

OPERABLE - OPERABILITY

A system, subsystem, train, component, or device shall be OPERABLE or have OPERABILITY when it is capable of performing its specified safety function(s) and when all necessary attendant instrumentation, controls, normal or emergency electrical power, cooling and seal water, lubrication, and other auxiliary equipment that are required for the system, subsystem, train, component, or device to perform its specified safety function(s) are also capable of performing their related support function(s).

PRIMARY PLANT VENTILATION SYSTEM

A PRIMARY PLANT VENTILATION SYSTEM shall be any system designed and installed to reduce gaseous radioiodine or radioactive material in particulate form in effluents by passing ventilation or vent exhaust gases through charcoal adsorbers and/or HEPA filters for the purpose of removing iodines or particulates from the gaseous exhaust stream prior to the release to the environment. Such a system is not considered to have any effect on noble gas effluents.

PURGE - PURGING

PURGE or PURGING shall be the controlled process of discharging air or gas from a confinement to maintain temperature, pressure, humidity, concentration or other operating conditions, in such a manner that replacement air or gas is required to purify the confinement.

DEFINITIONS

RATED THERMAL POWER

RATED THERMAL POWER shall be a total reactor core heat transfer rate to the reactor coolant of 3458 Mwt.

REPORTABLE EVENT

A REPORTABLE EVENT shall be any of those conditions specified in 10CFR50.73.

SITE BOUNDARY

The SITE BOUNDARY shall be that line as shown in Figure 5.1-3.

SOURCE CHECK

A SOURCE CHECK shall be the qualitative assessment of channel response when the channel sensor is exposed to a source of increased radioactivity.

THERMAL POWER

THERMAL POWER shall be the total reactor core heat transfer rate to the reactor coolant.

UNRESTRICTED AREA

An UNRESTRICTED AREA means any area beyond the SITE BOUNDARY.

VENTING

VENTING shall be the controlled process of discharging air or gas from a confinement to maintain temperature, pressure, humidity, concentration, or other operating condition, in such a manner that replacement air or gas is not provided or required during VENTING. Vent, used in system names, does not imply a VENTING process.

WASTE GAS HOLDUP SYSTEM

A WASTE GAS HOLDUP SYSTEM shall be any system designed and installed to reduce radioactive gaseous effluents by collecting Reactor Coolant System offgases from the Reactor Coolant System and providing for delay or holdup for the purpose of reducing the total radioactivity prior to release to the environment.

CONTROLLED AREA

A CONTROLLED AREA means an area outside of a restricted area, as defined in 10 CFR 20.1003, but inside the SITE BOUNDARY, access to which can be limited by the licensee for any reason.

TABLE 1.1
ODCM FREQUENCY NOTATION

NOTATION	FREQUENCY
S	At least once per 12 hours.
D	At least once per 24 hours.
W	At least once per 7 days.
M	At least once per 31 days
Q	At least once per 92 days.
SA	At least once per 184 days.
SR	At least once per 9 months.
R	At least once per 18 months.
S/U	Prior to each reactor startup.
N.A.	Not applicable.
P	Completed prior to each release.

TABLE 1.2
This Table is Deleted.

SECTION 2.0

NOT USED

SECTIONS 3.0 AND 4.0
CONTROLS
AND
SURVEILLANCE REQUIREMENTS

3/4 CONTROLS AND SURVEILLANCE REQUIREMENTS

3/4.0 APPLICABILITY

The guidance provided for the use and application of LIMITING CONDITION FOR OPERATION (LCO) APPLICABILITY in Section 3.0, "LIMITING CONDITION FOR OPERATION (LCO) APPLICABILITY" of the Technical Specifications is applicable to the Controls contained in this manual, except as noted below.

The guidance provided for the use and application of SURVEILLANCE REQUIREMENT (SR) APPLICABILITY in Section 3.0, "SURVEILLANCE REQUIREMENT (SR) APPLICABILITY" of the Technical Specifications is applicable to the Surveillance Requirements contained in this manual.

For the purpose of the ODCM, the ODCM terms specified below should be considered synonymous with the listed Technical Specification term:

<u>ODCM</u>	<u>Technical Specification</u>
Control	LCO
ACTION	Required Action

A cross reference between Section 3/4.0 of the Offsite Dose Calculation Manual (ODCM) and the applicable Section 3.0 of the Technical Specifications is as follows:

<u>ODCM Control:</u>	<u>Technical Specification Section</u>
3.0.1	LCO 3.0.1
3.0.2	LCO 3.0.2
N/A (see Note 1)	LCO 3.0.3
N/A (see Note 1)	LCO 3.0.4
N/A (see Note 1)	LCO 3.0.5
N/A (see Note 1)	LCO 3.0.6
N/A (see Note 1)	LCO 3.0.7

<u>ODCM Surveillance Requirement:</u>	<u>Technical Specification Section</u>
4.0.1	SR 3.0.1
4.0.2	SR 3.0.2
4.0.3	SR 3.0.3
N/A (see Note 1)	SR 3.0.4

- NOTE 1 -

The provisions of the cross referenced Technical Specification LCO/SR are not pertinent for use in the ODCM; therefore, the Technical Specification LCO/SR is not applicable (N/A).

INSTRUMENTATION

RADIOACTIVE LIQUID EFFLUENT MONITORING INSTRUMENTATION

CONTROLS

3.3.3.4 In accordance with CPSES TS 5.5.4.a, the radioactive liquid effluent monitoring instrumentation channels shown in Table 3.3-7 shall be OPERABLE with their Alarm/Trip Setpoints set to ensure that the limits of Control 3.11.1.1 are not exceeded. The Alarm/Trip Setpoints of these channels shall be determined and adjusted in accordance with the methodology and parameters in Part II of the OFFSITE DOSE CALCULATION MANUAL (ODCM).

APPLICABILITY: At all times.

ACTION:

- a. With a radioactive liquid effluent monitoring instrumentation channel Alarm/Trip Setpoint less conservative than required by the above Control, immediately suspend the release of radioactive liquid effluents monitored by the affected channel, or declare the channel inoperable, or change the setpoint so it is acceptably conservative.
- b. With less than the minimum number of radioactive liquid effluent monitoring instrumentation channels OPERABLE, take the ACTION shown in Table 3.3-7. Restore the inoperable instrumentation to OPERABLE status within 30 days and, if unsuccessful, explain in the next Radioactive Effluent Release Report pursuant to Control 6.9.1.4 why this inoperability was not corrected in a timely manner.

SURVEILLANCE REQUIREMENTS

4.3.3.4 Each radioactive liquid effluent monitoring instrumentation channel shall be demonstrated OPERABLE by performance of the CHANNEL CHECK, SOURCE CHECK, CHANNEL CALIBRATION, and DIGITAL CHANNEL OPERATIONAL TEST or ANALOG CHANNEL OPERATIONAL TEST at the frequencies shown in Table 4.3-3.

TABLE 3.3-7
RADIOACTIVE LIQUID EFFLUENT MONITORING INSTRUMENTATION

INSTRUMENT	MINIMUM CHANNELS OPERABLE	ACTION
1. Radioactivity Monitors Providing Alarm and Automatic Termination of Release		
a. Liquid Radwaste Effluent Line (XRE-5253)	1	30
b. Turbine Building (Floor Drains) Sumps Effluent Lines (1RE-5100 & 2RE-5100)	1/sump	31
c. Auxiliary Building to LVW Pond Liquid Effluent Line (XRE-5251A)	1	31A
2. Radioactivity Monitors Providing Alarm But Not Providing Automatic Termination of Release		
a. Service Water System Effluent Lines (1RE-4269, 1RE-4270, 2RE-4269 & 2RE-4270)	1/train	32
3. Flow Rate Measurement Devices		
a. Liquid Radwaste Effluent Line (XFT-5288)	1	33

TABLE 3.3-7 (Continued)

ACTIONS STATEMENTS

ACTION 30- With the number of channels OPERABLE less than required by the Minimum Channels OPERABLE requirement, effluent releases via this pathway may continue provided that prior to initiating a release:

- a. At least two independent samples are analyzed in accordance with Control 4.11.1.1.1; and
- b. At least two technically qualified members of the facility staff independently verify the release rate calculations and discharge line valving.

Otherwise, suspend release of radioactive effluents via this pathway.

ACTION 31- With the number of channels OPERABLE less than required by the Minimum Channels OPERABLE requirement, effluent releases via this pathway may continue provided grab samples are analyzed for principal gamma emitters at a lower limit of detection of no more than 5×10^{-7} microCurie/ml:

- a. At least once per 12 hours when the specific activity of the secondary coolant is greater than 0.01 microCurie/gram DOSE EQUIVALENT I-131; or
- b. At least once per 24 hours when the specific activity of the secondary coolant is less than or equal to 0.01 microCurie/gram DOSE EQUIVALENT I-131. (Refer to Notation 3 of Table 4.11-1 for the applicability of the LLD requirement.)

ACTION 31A- With number of channels OPERABLE less than required by the Minimum Channels OPERABLE requirement, effluent releases via this pathway may continue provided grab samples are analyzed for principal gamma emitters at a lower-limit of detection of no more than 5×10^{-7} microCurie/ml at least once per 12 hours.

ACTION 32- With the number of channels OPERABLE less than required by the Minimum Channels OPERABLE requirement, operations may continue provided that:

- a. With the component cooling water monitors (uRE-4509, uRE-4510, &uRE-4511)* OPERABLE and indicating an activity of less than 1×10^{-4} micro Curie/ml, a grab sample is collected and analyzed for principal gamma emitters at a lower limit of detection of no more than 5×10^{-7} microCurie/ml at least every 31 days; or

* "u" designates monitor for the applicable unit, e.g., 1 or 2.

TABLE 3.3-7 (Continued)

ACTIONS STATEMENTS (Continued)

- b. At least once per 12 hours, grab samples are collected and analyzed for principal gamma emitters at a lower limit of detection of no more than 5×10^{-7} microCurie/ml. (Refer to Notation 3 of Table 4.11-1 for the applicability of the LLD requirement.)

NOTE: Collection of grab samples is not required when there is no process flow at the monitor.

ACTION 33- With the number of channels OPERABLE less than required by the Minimum Channels OPERABLE requirement, effluent releases via this pathway may continue provided the flow rate is estimated at least once per 4 hours during actual releases. Pump performance curves generated in place may be used to estimate flow.

TABLE 4.3-3
RADIOACTIVE LIQUID EFFLUENT MONITORING INSTRUMENTATION SURVEILLANCE REQUIREMENTS

INSTRUMENT	CHANNEL CHECK	SOURCE CHECK	CHANNEL CALIBRATION	ANALOG CHANNEL OPERATIONAL TEST	DIGITAL CHANNEL OPERATIONAL TEST
1. Radioactivity Monitors Providing Alarm and Automatic Termination of Release					
a. Liquid Radwaste Effluent Line (XRE-5253)	D	P	R(4)	N.A.	Q(1)
b. Turbine Building (Floor Drains) Sumps Effluent Lines (1RE-5100 & 2RE-5100)	D	M	R(4)	N.A.	Q(2)
c. Auxiliary Building to LVW Pond Liquid Effluent Line (XRE-5251A)	D	M	R(4)	N.A.	Q(2)
2. Radioactivity Monitors Providing Alarm But Not Providing Automatic Termination of Release					
a. Service Water System Effluent Lines (1RE-4269, 1RE-4270, 2RE-4269 & 2RE-4270)	D	M	R(4)	N.A.	Q(3)
3. Flow Rate Measurement Devices					
a. Liquid Radwaste Effluent Line (XFT-5288)	D(5)	N.A.	R	Q	N.A.

TABLE 4.3-3 (Continued)

TABLE NOTATIONS

- (1) The DIGITAL CHANNEL OPERATIONAL TEST shall also demonstrate that automatic isolation of this pathway and Control Room alarm annunciation occur if any of the following conditions exist:
 - a. Instrument indicates measured levels above the Alarm/Trip Setpoint; or
 - b. Circuit failure (Channel Out of Service - Loss of Power, Loss of Counts, Loss of Sample Flow, or Check Source Failure).

- (2) The DIGITAL CHANNEL OPERATIONAL TEST shall also demonstrate that automatic flow diversion of this pathway (from the Low Volume Waste Treatment System to the Co-Current Waste Treatment System) and Control Room alarm annunciation occur if any of the following conditions exist:
 - a. Instrument indicates measured levels above the Alarm/Trip Setpoint; or
 - b. Circuit failure (Channel Out of Service - Loss of Power, Loss of Counts, or Check Source Failure).

- (3) The DIGITAL CHANNEL OPERATIONAL TEST shall also demonstrate that Control Room alarm annunciation occurs if any of the following conditions exist:
 - a. Instrument indicates measured levels above the Alarm Setpoint; or
 - b. Circuit failure (Channel Out of Service - Loss of Power, Loss of Counts, Loss of Sample Flow, or Check Source Failure).

- (4) The initial CHANNEL CALIBRATION shall be performed using one or more of the reference standards certified by the National Institute of Standards and Technology (NIST) or using standards that have been obtained from suppliers that participate in measurement assurance activities with NIST. These standards shall permit calibrating the system over its intended range of energy and measurement range. For subsequent CHANNEL CALIBRATION, sources that have been related to the initial calibration, reference standards certified by NIST, or standards that have been obtained from suppliers that participate in measurement assurance activities with NIST shall be used.

- (5) CHANNEL CHECK shall consist of verifying indication of flow during periods of release. CHANNEL CHECK shall be made at least once per 24 hours on days on which continuous, periodic, or batch releases are made.

INSTRUMENTATION

RADIOACTIVE GASEOUS EFFLUENT MONITORING INSTRUMENTATION

CONTROLS

3.3.3.5 In accordance with CPSES TS 5.5.4.a, the radioactive gaseous effluent monitoring instrumentation channels shown in Table 3.3-8 shall be OPERABLE with their Alarm/Trip Setpoints set to ensure that the limits of Control 3.11.2.1 are not exceeded. The Alarm/Trip Setpoints of these channels shall be determined and adjusted in accordance with the methodology and parameters in Part II of the ODCM.

APPLICABILITY: As shown in Table 3.3-8.

ACTION:

- a. With a radioactive gaseous effluent monitoring instrumentation channel Alarm/Trip Setpoint less conservative than required by the above Control, immediately suspend the release of radioactive gaseous effluents monitored by the affected channel, or declare the channel inoperable, or change the setpoint so it is acceptably conservative.
- b. With less than the minimum number of radioactive gaseous effluent monitoring instrumentation channels OPERABLE, take the ACTION shown in Table 3.3-8. Restore the inoperable instrumentation to OPERABLE status within 30 days and, if unsuccessful, explain in the next Radioactive Effluent Release Report pursuant to Control 6.9.1.4 why this inoperability was not corrected in a timely manner.

SURVEILLANCE REQUIREMENTS

4.3.3.5 Each radioactive gaseous effluent monitoring instrumentation channel shall be demonstrated OPERABLE by performance of the CHANNEL CHECK, SOURCE CHECK, CHANNEL CALIBRATION, and DIGITAL CHANNEL OPERATIONAL TEST or ANALOG CHANNEL OPERATIONAL TEST at the frequencies shown in Table 4.3-4.

TABLE 3.3-8
RADIOACTIVE GASEOUS EFFLUENT MONITORING INSTRUMENTATION

INSTRUMENT	MINIMUM CHANNELS OPERABLE	APPLICABILITY	ACTION
1. WASTE GAS HOLDUP SYSTEM			
a. Noble Gas Release Rate Monitor - Providing Alarm and Automatic Termination of Release [XRE-5570A & XRE-5570B (effluent release rate channel)]	1/stack	**	34
2. PRIMARY PLANT VENTILATION			
a. Noble Gas Release Rate Monitor [XRE-5570A & XRE-5570B (effluent release rate channel)]	1/stack	*	36
b. Iodine Sampler (WRGM sample skid)	1/stack	*	37
c. Particulate Sampler (WRGM sample skid)	1/stack	*	37
d. Sampler Flow Rate Monitor SMPL Flow 1 (X-RFT-5570A-1, X-RFT-5570B-1)	1/stack	*	35

TABLE 3.3-8 (Continued)

TABLE NOTATIONS

* At all times.

** During Batch Radioactive Releases via this pathway.

ACTION 34- With the number of channels OPERABLE less than required by the Minimum Channels OPERABLE requirement, the contents of the tank(s) may be released to the environment provided that prior to initiating the release:

- a. The auxiliary building vent duct monitor (XRE-5701) is confirmed OPERABLE; or
- b. At least two independent samples of the tank's contents are analyzed; and
- c. At least two technically qualified members of the facility staff independently verify the release rate calculations and discharge valve lineup.

Otherwise, suspend release of radioactive effluents via this pathway.

ACTION 35- With the number of channels OPERABLE less than required by the Minimum Channels OPERABLE requirement, effluent releases via this pathway may continue provided the sample flow rate is estimated at least once per 4 hours.

ACTION 36- With the number of channels OPERABLE less than required by the Minimum Channels OPERABLE requirement, effluent releases via this pathway may continue provided that:

- a. A Plant Vent Noble Gas Activity Monitor (XRE-5570A, XRE-5570B (low range activity) or XRE-5567A, XRE-5567B) is OPERABLE, and the plant vent flow rate is estimated at least once per 4 hours; or
- b. The Plant Vent Flow Monitor, PROC FLOW N (X-FT-5570A-1, X-FT-5570B-1), is OPERABLE, and an alternate Plant Vent Noble Gas Activity Monitor is OPERABLE (XRE-5567A, XRE-5567B) or grab samples are taken at least once per 12 hours and these samples are analyzed for radioactivity within 24 hours; or
- c. The plant vent flow rate is estimated at least once per 4 hours, and grab samples are taken at least once per 12 hours and these samples are analyzed for radioactivity within 24 hours.

ACTION 37- With the number of channels OPERABLE less than required by the Minimum Channels OPERABLE requirement, effluent releases via the affected pathway may continue provided samples are continuously collected with auxiliary sampling equipment as required in Table 4.11-2.

TABLE 3.3-8 (Continued)

TABLE NOTATIONS

If the number of channels OPERABLE is less than required by the "minimum Channels OPERABLE" requirement due to loss of heat tracing, then declare the Iodine & Particulate samplers INOPERABLE. Restore the heat tracing within 7 days and declare the samplers OPERABLE or initiate action in accordance with the Corrective Action Program to restore the channel(s) to operable status as soon as practical.

TABLE 4.3-4
RADIOACTIVE GASEOUS EFFLUENT MONITORING INSTRUMENTATION SURVEILLANCE REQUIREMENTS

INSTRUMENT	CHANNEL CHECK	SOURCE CHECK	CHANNEL CALIBRATION	ANALOG CHANNEL OPERATIONAL TEST	DIGITAL CHANNEL OPERATIONAL TEST
1. WASTE GAS HOLDUP SYSTEM					
a. Noble Gas Release Rate Monitor - Providing Alarm and Automatic Termination of Release [XRE-5570A, XRE-5570B (effluent release rate channel)]	P	P	R(3)	N.A.	Q(1)
2. PRIMARY PLANT VENTILATION					
a. Noble Gas Release Rate Monitor [XRE-5570A, XRE-5570B (effluent release rate channel)]	D	#	R(3)	N.A.	Q(2)
b. Iodine Sampler (WRGM sample skid)	W(4)	N.A.	N.A.	N.A.	N.A.
c. Particulate Sampler (WRGM Sample Skid)	W(4)	N.A.	N.A.	N.A.	N.A.
d. Sampler Flow Rate Monitor SMPL Flow 1 (X-RFT-5570A-1, X-RFT-5570B-1)	D	N.A.	R	Q	N.A.

TABLE 4.3-4 (Continued)

TABLE NOTATIONS

- # Prior to any release from the WASTE GAS HOLDUP SYSTEM or containment PURGING or VENTING, not to exceed 31 days.
- (1) The DIGITAL CHANNEL OPERATIONAL TEST shall also demonstrate that automatic isolation of this pathway and control room alarm annunciation occurs if any of the following conditions exist:
 - a. Instrument indicates measured levels above the Alarm/Trip Setpoint; or
 - b. Circuit failure (Channel Out of Service - Loss of Power, Loss of Counts, Loss of Sample Flow, or Check Source Failure).
- (2) The DIGITAL CHANNEL OPERATIONAL TEST shall also demonstrate that control room alarm annunciation occurs if any of the following conditions exist:
 - a. Instrument indicates measured levels above the Alarm Setpoint; or
 - b. Circuit failure (Channel Out of Service - Loss of Power, Loss of Counts, Loss of Sample Flow, or Check Source Failure).
- (3) The initial CHANNEL CALIBRATION shall be performed using one or more of the reference standards certified by the National Institute of Standards and Technology (NIST) or using standards that have been obtained from suppliers that participate in measurement assurance activities with NIST. These standards shall permit calibrating the system over its intended range of energy and measurement range. For subsequent CHANNEL CALIBRATION, sources that have been related to the initial calibration, reference standards certified by NIST, or standards that have been obtained from suppliers that participate in measurement assurance activities with NIST shall be used.
- (4) The CHANNEL CHECK shall consist of visually verifying that the collection element (i.e., filter or cartridge. etc.) is in place for sampling.

INSTRUMENTATION

METEOROLOGICAL MONITORING INSTRUMENTATION

CONTROLS

3.3.3.6 The meteorological monitoring instrumentation channels shown in Table 3.3-9 shall be OPERABLE.

APPLICABILITY: At all times.

ACTION:

- a. With less than the minimum number of meteorological monitoring instrumentation channels OPERABLE for more than 7 days, initiate action in accordance with the Corrective Action Program to restore the channel(s) to operable status as soon as practical.

SURVEILLANCE REQUIREMENTS

4.3.3.6 Each of the above meteorological monitoring instrumentation channels shall be demonstrated OPERABLE:

- a. At least once per 24 hours by performance of a CHANNEL CHECK; and
- b. At least once per 184 days by performance of a CHANNEL CALIBRATION except the wind speed and wind direction sensors which are replaced with calibrated sensors at least once per 12 months.

TABLE 3.3-9
METEOROLOGICAL MONITORING INSTRUMENTATION

INSTRUMENT CHANNEL	LOCATION	MINIMUM OPERABLE
1. WIND SPEED		1 of 3
a. X-S-4117	Nominal Elev. 60 m.	
b. X-S-4118	Nominal Elev. 10 m.	
c. X-S-4128*	Nominal Elev. 10 m.	
2. WIND DIRECTION		1 of 3
a. X-Z-4115	Nominal Elev. 60 m	
b. X-Z-4116	Nominal Elev. 10 m.	
c. X-Z-4126*	Nominal Elev. 10 m.	
3. AIR TEMPERATURE - ΔT		1 of 2
a. X-T-4119	Nominal Elev. 60 m. and Nominal Elev. 10 m.	
b. X-T-4120	Nominal Elev. 60 m. and Nominal Elev. 10 m.	

* Mounted on backup tower.

INSTRUMENTATION

SEALED SOURCE CONTAMINATION

CONTROLS

3.7.15 Each sealed source containing radioactive material either in excess of 100 microCuries of beta and/or gamma emitting material or 5 microCuries of alpha emitting material shall be free of greater than or equal to 0.005 microCurie of removable contamination.

APPLICABILITY: At all times.

ACTION:

With a sealed source having removable contamination in excess of the above limits, immediately withdraw the sealed source from use and either:

1. Decontaminate and repair the sealed source; or
2. Dispose of the sealed source in accordance with Commission Regulations.

SURVEILLANCE REQUIREMENTS

4.7.15.1 Test Requirements - Each sealed source shall be tested for leakage and/or contamination by:

- a. The licensee; or
- b. Other persons specifically authorized by the Commission or an Agreement State.

The test method shall have a detection sensitivity of at least 0.005 microCurie per test sample.

4.7.15.2 Test Frequencies - Each category of sealed sources (excluding startup sources and fission detectors previously subjected to core flux) shall be tested at the frequency described below.

- a. Sources in use - At least once per 6 months for all sealed sources containing radioactive materials:
 - 1) With a half-life greater than 30 days (excluding Hydrogen 3), and
 - 2) In any form other than gas.
- b. Stored sources not in use - Each sealed source and fission detector shall be tested prior to use or transfer to another licensee unless tested within the previous 6 months. Sealed sources and fission detectors transferred without a certificate indicating the last test date shall be tested prior to being placed into use; and

SURVEILLANCE REQUIREMENTS (Continued)

- c. Startup sources and fission detectors - Each sealed startup source and fission detector shall be tested prior to installation or within 31 days prior to being subjected to core flux and following repair or maintenance to the source.

4.7.15.3 Reports - A report shall be prepared and submitted to the Commission on an annual basis if sealed source or fission detector leakage tests reveal the presence of greater than or equal to 0.005 microCurie of removable contamination.

3/4.11 RADIOACTIVE EFFLUENTS

3/4.11.1 LIQUID EFFLUENTS

CONCENTRATION CONTROLS

3.11.1.1 In accordance with CPSES TS 5.5.4.b and 5.5.4.c the concentration of radioactive material released in liquid effluents from the site to CONTROLLED AREAS and UNRESTRICTED AREAS (see Figure 5.1-3) shall be limited to 10 times the concentrations specified in 10 CFR Part 20, Appendix B, Table 2, Column 2 for radionuclides other than dissolved or entrained noble gases. For dissolved or entrained noble gases, the concentration shall be limited to 2×10^{-4} microCurie/ml total activity.

APPLICABILITY: At all times.

ACTION:

- a. With the concentration of radioactive material released in liquid effluents to CONTROLLED AREAS and UNRESTRICTED AREAS exceeding the above limits, immediately restore the concentration to within the above limits.

SURVEILLANCE REQUIREMENTS

4.11.1.1.1 Radioactive liquid wastes shall be sampled and analyzed according to the sampling and analysis program of Table 4.11-1.

4.11.1.1.2 The results of the radioactivity analyses shall be used in accordance with the methodology and parameters in Part II of the ODCM to assure that the concentrations at the point of release are maintained within the limits of Control 3.11.1.1.

TABLE 4.11-1
RADIOACTIVE LIQUID WASTE SAMPLING AND ANALYSIS PROGRAM

LIQUID RELEASE TYPE	SAMPLING FREQUENCY	MINIMUM ANALYSIS FREQUENCY	TYPE OF ACTIVITY ANALYSIS	LOWER LIMIT OF DETECTION ⁽¹⁾ (μCi/ml)		
1A. Batch Waste Release ⁽²⁾ Tanks to the Circulating Water Discharge a. Waste Monitor Tanks b. Laundry Holdup & Monitor Tanks c. Waste Water Holdup Tanks ⁽⁸⁾ d. Plant Effluent Tanks	P Each Batch	P Each Batch	Principal Gamma Emitters ⁽³⁾	5.0E-07		
			I-131	1.0E-06		
			Dissolved & Entrained ⁽³⁾ Gases (Gamma Emitters)	1.0E-05		
				M Composite ⁽⁴⁾	H-3	1.0E-05
				Q Composite ⁽⁴⁾	Gross Alpha	1.0E-07
					Sr-89, Sr-90	5.0E-08
			Fe-55	1.0E-06		
1B. Batch Waste Release ⁽²⁾ Tanks to the Waste Water Management System a. Condensate Polisher Backwash Recovery Tanks ^(6,7) b. Waste Water Holdup Tanks ^(6,8) c. Temporary holdup tanks ⁽¹⁰⁾	P Each Batch	P Each Batch	Principal Gamma Emitters ⁽³⁾	5.0E-07		
			1-131	1.0E-06		
			H-3	1.0E-05		
2A. Continuous Release ⁽⁵⁾ to the Circulating Water Discharge a. Low Volume Waste Pond Effluents	Monthly Grab ⁽¹¹⁾	Monthly Grab ⁽¹¹⁾	Dissolved & Entrained ⁽³⁾ Gases (Gamma Emitters)	⁽¹¹⁾		
			Daily Grab Sample ⁽⁹⁾	Composite over pond discharge period ⁽⁴⁾	Principal Gamma Emitters ⁽³⁾	5.0E-07 ⁽¹¹⁾
	I-131	1.0E-06				
	H-3	1.0E-05				
	Gross Alpha	1.0E-07				
	Q Composite ⁽⁴⁾	Sr-89, Sr-90			5.0E-08	
		Fe-55	1.0E-06			
2B. Continuous Releases ⁽⁵⁾ to the Waste Water Management System a. Turbine Bldg. Sump No. 2 Effluents ^(6,7) b. Turbine Bldg. Sump No. 4 Effluents ^(6,7) c. Auxillary Bldg. Secondary Effluents ^(6,7)	W Grab Sample	W	Principal Gamma Emitters ⁽³⁾	5.0E-07		
			I-131	1.0E-06		
			H-3	1.0E-05		

TABLE 4.11-1 (Continued)

TABLE NOTATIONS

- (1) The LLD is defined, for purposes of these specifications, as the smallest concentration of radioactive material in a sample that will yield a net count, above system background, that will be detected with 95% probability with only 5% probability of falsely concluding that a blank observation represents a "real" signal.

For a particular measurement system, which may include radiochemical separation:

$$LLD = \frac{4.66s_b}{E \cdot V \cdot 2.22 \times 10^6 \cdot Y \cdot \exp(-\lambda\Delta t)}$$

Where:

- LLD = "A priori" lower limit of detection (microCurie per unit mass or volume),
- s_b = Standard deviation of the background counting rate or of the counting rate of a blank sample as appropriate (counts per minute),
- E = Counting efficiency (counts per disintegration),
- V = Sample size (units of mass or volume),
- 2.22×10^6 = Number of disintegrations per minute per microCurie,
- Y = Fractional radiochemical yield, when applicable,
- λ = Radioactive decay constant for the particular radionuclide (sec^{-1}), and
- Δt = Elapsed time between the midpoint of sample collection and the time of counting(s).

Typical values of E, V, Y, and Δt should be used in the calculation.

It should be recognized that the LLD is defined as an a priori (before the fact) limit representing the capability of a measurement system and not as an a posteriori (after the fact) limit for a particular measurement.

- (2) A batch release is the discharge of liquid wastes of a discrete volume. Prior to sampling for analyses, each batch shall be isolated, and then thoroughly mixed by a method described in Part II of the ODCM to assure representative sampling.
- (3) The principal gamma emitters for which the LLD specification applies include the following radionuclides: Mn-54, Fe-59, Co-58, Co-60, Zn-65, Mo-99, Cs-134, Cs-137, and Ce-141 for fission and corrosion products, and Kr-87, Kr-88, Xe-133, Xe-133m, Xe-135, and Xe-138 for dissolved or entrained gases. Ce-144 shall also be measured, but with an LLD of 5×10^{-6} . This list does not mean that only these nuclides are to be considered. Other gamma peaks that are identifiable, together with those of the above nuclides, shall

TABLE 4.11-1 (Continued)

TABLE NOTATIONS (Continued)

also be analyzed and reported in the Radioactive Effluent Release Report pursuant to Control 6.9.1.4 in the format outlined in Regulatory Guide 1.21, Appendix B, Revision 1, June 1974.

- (4) A composite sample is one in which the quantity of liquid sampled is proportional to the quantity of liquid waste discharged and in which the method of sampling employed results in a specimen that is representative of the liquids released.
- (5) A continuous release is the discharge of liquid wastes of a nondiscrete volume, e.g., from a volume of a system that has an input flow during the continuous release.
- (6) These waste streams shall be sampled and analyzed, in accordance with this table, if radioactive material is detected in the LVW Pond composite samples in concentrations that exceed 10% of the limits of 10 CFR 20, Appendix B, Table 2, Column 2. This sampling shall continue until 2 consecutive samples from the waste stream show that the concentration of radioactive materials in the waste stream is less than or equal to 10% of the limits of 10 CFR 20, Appendix B, Table 2, Column 2.
- (7) All flow from these waste streams shall be diverted to the Waste Water Holdup Tanks if activity is present in the waste stream in concentrations that exceed 10 times the limits of 10 CFR 20, Appendix B, Table 2, Column 2. Sampling and analysis of the respective Tanks or sumps are not required when flow is diverted to the Waste Water Holdup Tanks.
- (8) Waste Water Holdup Tanks (WWHT) shall be discharged directly to the Circulating Water Discharge Tunnel when results of sample analyses indicate activity in concentrations that exceed 10 times the limits of 10 CFR 20, Appendix B, Table 2, Column 2. Otherwise, WWHTs may be discharged to the Low Volume Waste Pond. WWHT discharges to the Circulating Water Discharge Tunnel shall be sampled and analyzed per Item 1A.c of this table. WWHT discharges to the LVW Pond shall be sampled and analyzed per Item 1B.b of this table.
- (9) Samples shall be taken at least once per 24 hours while the release is occurring. To be representative of the liquid effluent, the sample volume shall be proportioned to the effluent stream discharge volume. The ratio of sample volume to effluent discharge volume shall be maintained constant for all samples taken for the composite sample.
- (10) Temporary holdup tanks used to support special plant activities (e.g., Steam Generator Secondary Cleaning) involving potentially radioactive systems may be transferred to the Waste Water Management System when sampled in accordance with this table and the special plant activity has been evaluated in accordance with the 50.59 process. This waste stream shall not be discharged to the Waste Water Management System if activity is present in the waste stream in concentrations that exceed 10 times the limits of 10CFR20, Appendix B, Table 2, Column 2.
- (11) Dissolved and entrained gases should be included in the analysis (including Kr-87, Kr-88, Xe-133, Xe-133m, Xe-135, and Xe-138). There are no LLD requirements for these gases in the LVW samples since the half life of the isotopes are relatively short with respect to the sample counting frequency. Gases are also not expected to be found in the LVW due

TABLE 4.11-1 (Continued)

TABLE NOTATIONS (Continued)

to delay times associated with water being transported to the LVW and the open exposure of the ponds which would aid in the degasification of the liquids. One sample should be obtained monthly from the Low Volume Waste in addition to the composite sample to analyze for these noble gases. The count time for the sample should be equal to the time required to establish LLD values for the noble gas isotopes (e.g., 2000 seconds or the same count time used for effluent liquid batch releases).

RADIOACTIVE EFFLUENTS

DOSE

CONTROLS

3.11.1.2 In accordance with CPSES TS 5.5.4.d and 5.5.4.e the dose or dose commitment to a MEMBER OF THE PUBLIC from radioactive materials in liquid effluents released, from each unit, to CONTROLLED AREAS and UNRESTRICTED AREAS (see Figure 5.1-3) shall be limited:

- a. During any calendar quarter to less than or equal to 1.5 mrem to the whole body and to less than or equal to 5 mrem to any organ; and
- b. During any calendar year to less than or equal to 3 mrem to the whole body and to less than or equal to 10 mrem to any organ.

APPLICABILITY: At all times.

ACTION:

- a. With the calculated dose from the release of radioactive materials in liquid effluents exceeding any of the above limits, prepare and submit a report to the Commission within 30 days, pursuant to 10 CFR 50, Appendix I, that identifies the cause(s) for exceeding the limit(s) and defines the corrective actions that have been taken to reduce the releases and the proposed corrective actions to be taken to assure that subsequent releases will be in compliance with the above limits. This report shall also include: (1) the results of radiological analyses of the drinking water source, and (2) the radiological impact on finished drinking water supplies with regard to the requirements of 40 CFR Part 141, Safe Drinking Water Act.

SURVEILLANCE REQUIREMENTS

4.11.1.2 Cumulative dose contributions from liquid effluents for the current calendar quarter and the current calendar year shall be determined in accordance with the methodology and parameters in Part II of the ODCM at least once per 31 days.

RADIOACTIVE EFFLUENTS

LIQUID RADWASTE TREATMENT SYSTEM

CONTROLS

3.11.1.3 In accordance with CPSES TS 5.5.4.f, the Liquid Radwaste Treatment System shall be OPERABLE and appropriate portions of the system shall be used to reduce releases of radioactivity when the projected doses due to the liquid effluent, from each unit, to CONTROLLED AREAS and UNRESTRICTED AREAS (see Figure 5.1-3) would exceed 0.06 mrem to the whole body or 0.2 mrem to any organ in a 31-day period.

APPLICABILITY: At all times.

ACTION:

- a. With radioactive liquid waste being discharged without treatment and in excess of the above limits and any portion of the Liquid Radwaste Treatment System not in operation, prepare and submit a report to the Commission within 30 days, pursuant to 10 CFR 50, Appendix I, that includes the following information:
 - 1) Explanation of why liquid radwaste was being discharged without treatment, identification of any inoperable equipment or subsystems, and the reason for the inoperability,
 - 2) Action(s) taken to restore the inoperable equipment to OPERABLE status, and
 - 3) Summary description of action(s) taken to prevent a recurrence.

SURVEILLANCE REQUIREMENTS

4.11.1.3.1 Doses due to liquid releases from each unit to CONTROLLED AREAS and UNRESTRICTED AREAS shall be projected at least once per 31 days in accordance with the methodology and parameters in Part II of the ODCM when Liquid Radwaste Treatment Systems are not being fully utilized.

4.11.1.3.2 The installed Liquid Radwaste Treatment System shall be considered OPERABLE by meeting Controls 3.11.1.1 and 3.11.1.2.

RADIOACTIVE EFFLUENTS

LVW POND RESIN INVENTORY

CONTROLS

3.11.1.4 The quantity of radioactive material contained in resins transferred to the LVW Pond shall be limited by the following expression:

$$\frac{264}{V} \cdot \sum_j \frac{A_j}{C_j} < 1.0$$

excluding tritium, dissolved or entrained noble gases, and radionuclides with less than an 8-day half-life,

where:

- A_j = Pond inventory limit for single radionuclide "j" (Curies),
- C_j = 10 CFR 20, Appendix B, Table 2, Column 2, concentration for single radionuclide "j" (microCuries/ml),
- V = Volume of resins in the pond (gallons), and
- 264 = Unit conversion factor (microCuries/Curie per milliliter/gallon).

APPLICABILITY: At all times.

ACTION:

- a. With the quantity of radioactive material contained in resins in the LVW Pond exceeding the above limit, immediately suspend all additions of resins to the pond.

SURVEILLANCE REQUIREMENTS

4.11.1.4 Prior to transferring any batch of used powdex resin to the pond, the total inventory of radioactive materials in resins contained in the pond, including the batch to be transferred, shall be determined to be within the above limit. The inventory shall be determined based on analysis of a representative sample of the resin batch. Decay of radionuclides in previously discharged resins may be taken into account in determining inventory levels.

RADIOACTIVE EFFLUENTS

LWW POND RESIN INVENTORY

SURVEILLANCE REQUIREMENTS (Continued)

Additionally, each batch of resins transferred to the pond shall be limited by the expression:

$$\sum_j \frac{Q_j}{C_j} \leq 0.1$$

where:

- Q_j = Concentration of radioactive materials (microCuries/ml) in wet, drained slurry (used powdex resin) for radionuclide "j", excluding tritium, dissolved or entrained noble gases, and radionuclides with less than an 8-day half-life. The analysis shall include at least Ce-144, Cs-134, Cs-137, Co-58 and Co-60. Estimates of the Sr-89 and Sr-90 batch concentration shall be included based on the most recent quarterly composite analysis,
- C_j = 10 CFR 20, Appendix B, Table 2, Column 2, concentration for single radionuclide "j" (microCuries/milliliter).

3/4.11 RADIOACTIVE EFFLUENTS

3/4.11.2 GASEOUS EFFLUENTS

DOSE RATE

3.11.2.1 In accordance with CPSES TS 5.5.4.c and 5.5.4.g, the dose rate due to radioactive materials released in gaseous effluents from the site to areas at or beyond the SITE BOUNDARY (see Figure 5.1-3) shall be limited to the following:

- a. For noble gases: Less than or equal to a dose rate of 500 mrems/yr to the total body and less than or equal to 3000 mrems/yr to the skin; and
- b. For Iodine-131, for Iodine-133, for tritium, and for all radionuclides in particulate form with half-lives greater than 8 days: Less than or equal to a dose rate of 1500 mrem/yr to any organ.

APPLICABILITY: At all times.

ACTION:

- a. With the dose rate(s) exceeding the above limits, immediately restore the release rate to within the above limits(s).

SURVEILLANCE REQUIREMENTS

4.11.2.1.1 Radioactive gaseous wastes shall be sampled and analyzed according to the sampling and analysis program of Table 4.11-2.

4.11.2.1.2 The results of the radioactivity analyses shall be used in accordance with the methodology and parameters in Part II of the ODCM to assure that the dose rates at or beyond the SITE BOUNDARY are maintained within the limits of Control 3.11.2.1.

TABLE 4.11-2
RADIOACTIVE GASEOUS WASTE SAMPLING AND
ANALYSIS PROGRAM (*)

GASEOUS RELEASE TYPE		SAMPLING FREQUENCY	MINIMUM ANALYSIS FREQUENCY	TYPE OF ACTIVITY ANALYSIS	LOWER LIMIT OF DETECTION (LLD) (1) ($\mu\text{Ci/ml}$)
1.	Waste Gas Storage Tank	P Each Tank Grab Sample	P Each Tank	Principal Gamma Emitters(2)	1×10^{-4}
2.	Containment Purge or Vent	P Each Release(3) Grab Sample	P Each Release(3)	Principal Gamma Emitters(2)	1×10^{-4}
			M	H-3 (oxide)	1×10^{-6}
3.	Plant Vent	M(3), (4), (5) Grab Sample	M(3)	Principal Gamma Emitters(2)	1×10^{-4}
				H-3 (oxide)	1×10^{-6}
		Continuous(6)	W(7) Radioiodine Adsorber	I-131	1×10^{-12}
		Continuous(6)	W(7) Particulate Sample	Principal Gamma Emitters(2)	1×10^{-11}
		Continuous(6)	M Composite Par- ticulate Sample	Gross Alpha	1×10^{-11}
		Continuous(6)	Q Composite Par- ticulate Sample	Sr-89, Sr-90	1×10^{-11}
		Continuous(6)	Noble Gas ** Beta or Gamma	Noble Gas	1×10^{-6}
4.	Outside Buildings	Grab sample	W(8)	Principle Gamma Emitters(2)	1×10^{-11}

* Table notations next page

**This sample is continuously analyzed by a radiation monitor

TABLE 4.11-2 (Continued)

TABLE NOTATIONS

- (1) The LLD is defined, for purposes of these specifications, as the smallest concentration of radioactive material in a sample that will yield a net count, above system background, that will be detected with 95% probability with only 5% probability of falsely concluding that a blank observation represents a "real" signal.

For a particular measurement system, which may include radiochemical separation:

$$LLD = \frac{4.66s_b}{E \cdot V \cdot 2.22 \times 10^6 \cdot Y \cdot \exp(-\lambda\Delta t)}$$

Where:

- LLD = the "a priori" lower limit of detection (microCurie per unit mass or volume),
- s_b = Standard deviation of the background counting rate or of the counting rate of a blank sample as appropriate (counts per minute),
- E = Counting efficiency (counts per disintegration),
- V = Sample size (units of mass or volume),
- 2.22×10^6 = Number of disintegrations per minute per microCurie,
- Y = Fractional radiochemical yield, when applicable,
- λ = Radioactive decay constant for the particular radionuclide (sec^{-1}), and
- Δt = Elapsed time between the midpoint of sample collection and the time of counting(s).

Typical values of E, V, Y, and Δt should be used in the calculation.

It should be recognized that the LLD is defined as an a priori (before the fact) limit representing the capability of a measurement system and not as an a posteriori (after the fact) limit for a particular measurement.

- (2) The principal gamma emitters for which the LLD specification applies include the following radionuclides: Kr-87, Kr-88, Xe-133, Xe-133m, Xe-135, and Xe-138 in noble gas releases and Mn-54, Fe-59, Co-58, Co-60, Zn-65, I-131, Cs-134, Cs-137, Ce-141 and Ce-144 in iodine and particulate releases. This list does not mean that only these nuclides are to be considered. In the case of release type 4, Outside Buildings, noble gases and iodine may not be sampled based on an evaluation of the source term. Other gamma peaks that are identifiable, together with those of the above nuclides, shall also be analyzed and reported in the Radioactive Effluent Release Report, pursuant to Control 6.9.1.4, in the format outlined in Regulatory Guide 1.21, Appendix B, Revision 1, June 1974.

TABLE 4.11-2 (Continued)

TABLE NOTATIONS (Continued)

- (3) Sampling and analysis shall also be performed following shutdown, startup, or a THERMAL POWER change $\geq 15\%$ of RATED THERMAL POWER within a 1-hour period. This requirement does not apply if: (1) analysis of primary coolant activity performed pursuant to Technical Specification 3.4.16 shows that the DOSE EQUIVALENT I-131 concentration in the primary coolant has not increased more than a factor of 3, and (2) noble gas monitoring shows that effluent activity has not increased more than a factor of 3.
- (4) Tritium grab samples shall be taken at least once per 24 hours when the refueling canal is flooded.
- (5) Tritium grab samples shall be taken at least once per 7 days from the ventilation exhaust from the spent fuel pool area, whenever spent fuel is in the spent fuel pool.
- (6) The ratio of the sample flow rate to the sampled stream flow rate shall be known for the time period covered by each dose or dose rate calculation made in accordance with Controls 3.11.2.1, 3.11.2.2, and 3.11.2.3.
- (7) Samples shall be changed at least once per 7 days and analyses shall be completed within 48 hours after changing, or after removal from the sampler. Sampling shall also be performed at least once per 24 hours for at least 7 days following each shutdown, startup or THERMAL POWER change $\geq 15\%$ of RATED THERMAL POWER within a 1-hour period and analyses shall be completed within 48 hours of changing. When samples collected for 24 hours are analyzed, the corresponding LLDs may be increased by a factor of 10. This requirement does not apply if: (1) analysis shows that the DOSE EQUIVALENT I-131 concentration in the reactor coolant has not increased more than a factor of 3; and (2) noble gas monitoring shows that effluent activity has not increased more than a factor of 3.
- (8) Samples shall be changed at least once per seven (7) days and analysis shall be completed within 48 hours after changing, or after removal from the sampler. This requirement does not apply, if no activities are being conducted in the Outside Building that would generate radioactive effluent.

RADIOACTIVE EFFLUENTS

DOSE - NOBLE GASES

CONTROLS

3.11.2.2 In accordance with CPSES TS 5.5.4.e and 5.5.4.h, the air dose due to noble gases released in gaseous effluents, from each unit, to areas at and beyond the SITE BOUNDARY (see Figure 5.1-3) shall be limited to the following:

- a. During any calendar quarter: Less than or equal to 5 mrad for gamma radiation and less than or equal to 10 mrad for beta radiation; and
- b. During any calendar year: Less than or equal to 10 mrad for gamma radiation and less than or equal to 20 mrad for beta radiation.

APPLICABILITY: At all times.

ACTION:

- a. With the calculated air dose from radioactive noble gases in gaseous effluents exceeding any of the above limits, prepare and submit a report to the NRC within 30 days, pursuant to 10 CFR 50, Appendix I, that identifies the cause(s) for exceeding the limit(s) and defines the corrective actions that have been taken to reduce the releases and the proposed corrective actions to be taken to assure that subsequent releases will be in compliance with the above limits.

SURVEILLANCE REQUIREMENTS

4.11.2.2 Cumulative dose contributions for the current calendar quarter and current calendar year for noble gases shall be determined in accordance with the methodology and parameters in Part II of the ODCM at least once per 31 days.

RADIOACTIVE EFFLUENTS

DOSE - IODINE-131, IODINE-133, TRITIUM, AND RADIOACTIVE MATERIAL IN PARTICULATE FORM

CONTROLS

3.11.2.3 In accordance with CPSES TS 5.5.4.e and 5.5.4.i, the dose to a MEMBER OF THE PUBLIC from Iodine-131, Iodine-133, tritium, and all radionuclides in particulate form with half-lives greater than 8 days in gaseous effluents released, from each unit, to areas at and beyond the SITE BOUNDARY (see Figure 5.1-3) shall be limited to the following:

- a. During any calendar quarter: Less than or equal to 7.5 mremS to any organ; and
- b. During any calendar year: Less than or equal to 15 mremS to any organ.

APPLICABILITY: At all times.

ACTION:

- a. With the calculated dose from the release of Iodine-131, Iodine-133, tritium, and radionuclides in particulate form with half-lives greater than 8 days in gaseous effluents exceeding any of the above limits, prepare and submit a report to the NRC within 30 days, pursuant to 10 CFR 50, Appendix I, that identifies the cause(s) for exceeding the limit and defines the corrective actions that have to be taken to assure that subsequent releases will be in compliance with the above limits.

SURVEILLANCE REQUIREMENTS

4.11.2.3 Cumulative dose contributions for the current calendar quarter and current calendar year for Iodine-131, Iodine-133, tritium, and radionuclides in particulate form with half-lives greater than 8 days shall be determined in accordance with the methodology and parameters in Part II of the ODCM at least once per 31 days.

RADIOACTIVE EFFLUENTS

GASEOUS RADWASTE TREATMENT SYSTEM

CONTROLS

3.11.2.4 In accordance with CPSES TS 5.5.4.f, the PRIMARY PLANT VENTILATION SYSTEM and the WASTE GAS HOLDUP SYSTEM shall be OPERABLE and appropriate portions of these systems shall be used to reduce releases of radioactivity when the projected doses in 31 days due to gaseous effluent releases, from each unit, to areas at and beyond the SITE BOUNDARY (see Figure 5.1-3) would exceed:

- a. 0.2 mrad to air from gamma radiation, or
- b. 0.4 mrad to air from beta radiation, or
- c. 0.3 mrem to any organ of a MEMBER OF THE PUBLIC.

APPLICABILITY: At all times.

ACTION:

- a. With radioactive gaseous waste being discharged without treatment and in excess of the above limits, prepare and submit a report to the NRC within 30 days, pursuant to 10 CFR 50, Appendix I, that includes the following information:
 - 1) Identification of any inoperable equipment or subsystems, and the reason for the inoperability,
 - 2) Action(s) taken to restore the inoperable equipment to OPERABLE status, and
 - 3) Summary description of action(s) taken to prevent a recurrence.

SURVEILLANCE REQUIREMENTS

4.11.2.4.1 Doses due to gaseous releases from each unit to areas at and beyond the SITE BOUNDARY shall be projected at least once per 31 days in accordance with the methodology and parameters in Part II of the ODCM when Gaseous Radwaste Treatment Systems are not being fully utilized.

4.11.2.4.2 The installed PRIMARY PLANT VENTILATION SYSTEM and WASTE GAS HOLDUP SYSTEM shall be considered OPERABLE by meeting Controls 3.11.2.1 and 3.11.2.2 or 3.11.2.3.

3/4.11 RADIOACTIVE EFFLUENTS

3/4.11.4 TOTAL DOSE

CONTROLS

3.11.4 In accordance with CPSES TS 5.5.4.j, the annual (calendar year) dose or dose commitment to any MEMBER OF THE PUBLIC due to releases of radioactivity and to radiation from uranium fuel cycle sources shall be limited to less than or equal to 25 mremS to the total body or any organ, except the thyroid, which shall be limited to less than or equal to 75 mremS.

APPLICABILITY: At all times.

ACTION:

- a. With the calculated doses from the release of radioactive materials in liquid or gaseous effluents exceeding twice the limits of Controls 3.11.1.2a., 3.11.1.2b, 3.11.2.2a, 3.11.2.2b, 3.11.2.3a., or 3.11.2.3b., calculations shall be made including direct radiation contributions from the units and from outside storage tanks to determine whether the above limits of Control 3.11.4 have been exceeded. If such is the case, prepare and submit a report to the NRC within 30 days, pursuant to 10 CFR 20.1301(d) and 10 CFR 20.2203(a)(4) that defines the corrective action to be taken to reduce subsequent releases to prevent recurrence of exceeding the above limits and includes the schedule for achieving conformance with the above limits. This report, as defined in 10 CFR 20.2203(b), shall include an analysis that estimates the radiation exposure (dose) to a MEMBER OF THE PUBLIC from uranium fuel cycle sources, including all effluent pathways and direct radiation, for the calendar year that includes the release(s) covered by this report. It shall also describe levels of radiation and concentration of radioactive material involved, and the cause of the exposure levels or concentrations. If the estimated dose(s) exceeds the above limits, and if the release condition resulting in violation of 40 CFR Part 190 has not already been corrected, the report shall include a request for a variance in accordance with the provisions of 40 CFR Part 190. Submittal of the report is considered a timely request, and a variance is granted until staff action on the request is complete.

SURVEILLANCE REQUIREMENTS

4.11.4.1 Cumulative dose contributions from liquid and gaseous effluents shall be determined in accordance with Controls 4.11.1.2, 4.11.2.2, and 4.11.2.3, and in accordance with the methodology and parameters in Part II of the ODCM.

4.11.4.2 Cumulative dose contributions from direct radiation from the units and from radwaste storage tanks shall be determined in accordance with the methodology and parameters in Part II of the ODCM. This requirement is applicable only under conditions set forth in ACTION a. of Control 3.11.4.

3/4.12 RADIOLOGICAL ENVIRONMENTAL MONITORING

3/4.12.1 MONITORING PROGRAM

CONTROLS

3.12.1 The Radiological Environmental Monitoring Program shall be conducted as specified in Table 3.12-1.

APPLICABILITY: At all times.

ACTION:

- a. With the Radiological Environmental Monitoring Program not being conducted as specified in Table 3.12-1, prepare and submit to the NRC, in the Annual Radiological Environmental Operating Report required by Control 6.9.1.3, a description of the reason(s) for not conducting the program as required and the plan for preventing a recurrence.
- b. With the level of radioactivity as the result of plant effluents in an environmental sampling medium at a specified location exceeding the reporting levels of Table 3.12-2 when averaged over any calendar quarter, prepare and submit a report to the NRC within 30 days, pursuant to 10 CFR 50, Appendix I, that identifies the cause(s) for exceeding the limit(s) and defines the corrective action to be taken to reduce radioactive effluents so that the potential annual dose* to a MEMBER OF THE PUBLIC is less than the calendar year limits of Control 3.11.1.2, 3.11.2.2, or 3.11.2.3. When more than one of the radionuclides in Table 3.12-2 are detected in the sampling medium, this report shall be submitted if:

$$\frac{\text{concentration (1)}}{\text{reporting level (1)}} + \frac{\text{concentration (2)}}{\text{reporting level (2)}} + \dots \geq 1.0$$

When radionuclides other than those in Table 3.12-2 are detected and are the result of plant effluents, this report shall be submitted if the potential annual dose* to A MEMBER OF THE PUBLIC from all radionuclides is equal to or greater than the calendar year limits of Control 3.11.1.2, 3.11.2.2, or 3.11.2.3. This report is not required if the measured level of radioactivity was not the result of plant effluents; however, in such an event, the condition shall be reported and described in the Annual Radiological Environmental Operating Report required by Control 6.9.1.3.

* The methodology and parameters used to estimate the potential annual dose to a MEMBER OF THE PUBLIC shall be indicated in this report.

3/4.12 RADIOLOGICAL ENVIRONMENTAL MONITORING

3/4.12.1 MONITORING PROGRAM

CONTROLS (Continued)

- c. With milk or fresh leafy vegetable samples unavailable from one or more of the sample locations required by Table 3.12-1, identify locations for obtaining replacement samples and add them within 30 days to the Radiological Environmental Monitoring Program. The specific locations from which samples were unavailable may then be deleted from the monitoring program. New sampling locations shall be listed in the results of the annual Land Use Census.

SURVEILLANCE REQUIREMENTS

4.12.1 The radiological environmental monitoring samples shall be collected pursuant to Table 3.12-1 and shall be analyzed pursuant to the requirements of Table 3.12-1 and the detection capabilities required by Table 4.12-1. The specific sample locations for the Radiological Environmental Monitoring Program shall be listed and maintained current in the results of the annual Land Use Census.

TABLE 3.12-1
RADIOLOGICAL ENVIRONMENTAL MONITORING PROGRAM

EXPOSURE PATHWAY AND/OR SAMPLE	NUMBER OF REPRESENTATIVE SAMPLES AND SAMPLE LOCATIONS ⁽¹⁾	SAMPLING AND COLLECTION FREQUENCY	TYPE AND FREQUENCY OF ANALYSIS
1. Direct Radiation ⁽²⁾	<p>Forty routine monitoring stations either with two or more dosimeters or with one instrument for measuring and recording dose rate continuously, placed as follows:</p> <p>An inner ring of stations, one in each meteorological sector in the general area of the SITE BOUNDARY;</p> <p>An outer ring of stations, one in each meteorological sector in the 6- to 8-km range from the site; and</p> <p>The balance of the stations to be placed in special interest areas such as population centers, nearby residences, schools, and in one or two areas to serve as control stations.</p>	Quarterly	Gamma dose quarterly
2. Airborne Radioiodine and Particulates	<p>Samples from five locations:</p> <p>Three samples from close to the three SITE BOUNDARY locations, in different sectors, of the highest calculated annual average ground-level D/Q;</p>	Continuous sampler operation with sample collection weekly, or more frequently if required by dust loading.	<p><u>Radioiodine Canister:</u> I-131 analysis weekly</p> <p><u>Particulate Sampler:</u> Gross beta radioactivity analysis following filter change;⁽⁴⁾ and gamma isotopic analysis⁽⁵⁾ of composite (by location quarterly).</p>

TABLE 3.12-1 (Continued)
 RADIOLOGICAL ENVIRONMENTAL MONITORING PROGRAM

EXPOSURE PATHWAY AND/OR SAMPLE	NUMBER OF REPRESENTATIVE SAMPLES AND SAMPLE LOCATIONS ⁽¹⁾	SAMPLING AND COLLECTION FREQUENCY	TYPE AND FREQUENCY OF ANALYSIS
3. Waterborne	One sample from the vicinity of a community having the highest calculated annual average ground-level D/Q; and One sample from a control location, as for example 15 to 30 km distant and in the least prevalent wind direction. ⁽³⁾	Monthly composite of weekly grab samples.	Gamma isotopic analysis ⁽⁵⁾ monthly. Composite for tritium analysis quarterly.
a. Surface			
	Lake Granbury	Monthly composite of weekly grab samples when Lake Granbury is receiving letdown from SCR. Otherwise, monthly grab sample. ⁽⁷⁾	Gamma isotopic analysis ⁽⁵⁾ monthly. Composite for tritium analysis quarterly.
	Control-Brazos River upstream of Lake Granbury	Monthly	Gamma isotopic analysis ⁽⁵⁾ monthly. Composite for tritium analysis quarterly.
b. Ground	Samples from two sources if likely to be affected. ⁽⁸⁾	Quarterly	Gamma isotopic ⁽⁵⁾ and tritium analysis quarterly.

TABLE 3.12-1 (Continued)
RADIOLOGICAL ENVIRONMENTAL MONITORING PROGRAM

EXPOSURE PATHWAY AND/OR SAMPLE	NUMBER OF REPRESENTATIVE SAMPLES AND SAMPLE LOCATIONS ⁽¹⁾	SAMPLING AND COLLECTION FREQUENCY	TYPE AND FREQUENCY OF ANALYSIS
3. Waterborne (Continued)			
c. Drinking	One sample from Squaw Creek Reservoir.	Composite of weekly grab samples over 2-week period when I-131 analysis is performed; monthly composite of weekly grab samples otherwise.	I-131 analysis of each composite sample when the dose calculated for the consumption of the water is greater than 1 mrem per year ⁽⁹⁾ . Gross beta and gamma isotopic analyses ⁽⁵⁾ monthly. Composite for tritium analysis quarterly.
d. Sediment from Shoreline	One sample from downstream area with existing or potential recreational value.	Semiannually.	Gamma isotopic analysis ⁽⁵⁾ semiannually.
4. Ingestion			
a. Milk	Samples from milking animals in three locations within 5 km distance having the highest dose potential. If there are none, sample from milking animals in each of three areas between 5 to 8 km distant where doses are calculated to be greater than 1 mrem per yr. ⁽⁹⁾ One sample from milking animals at a control location, 15 to 30 km distant and in the least prevalent wind direction. ⁽³⁾	Semimonthly when animals are on pasture; monthly at other times.	Gamma isotopic ⁽⁵⁾ and I-131 analysis semimonthly when animals are on pasture; monthly at other times.

TABLE 3.12-1 (Continued)
 RADIOLOGICAL ENVIRONMENTAL MONITORING PROGRAM

EXPOSURE PATHWAY AND/OR SAMPLE	NUMBER OF REPRESENTATIVE SAMPLES AND SAMPLE LOCATIONS ⁽¹⁾	SAMPLING AND COLLECTION FREQUENCY	TYPE AND FREQUENCY OF ANALYSIS
4. Ingestion (Continued)			
b. Fish and Invertebrates	One sample of at least two recreationally important species in vicinity of plant discharge area. One sample of same species in areas not influenced by plant discharge.	Sample semiannually.	Gamma isotopic analysis ⁽⁵⁾ on edible portions semiannually
c. Food Products*	One sample of each principal class of food products from any area that is irrigated by water in which liquid plant wastes have been discharged.	At time of harvest ⁽¹⁰⁾	Gamma isotopic analysis ⁽⁵⁾ on edible portion following sample collection.
	A sample of broad leaf vegetation grown nearest each of two different offsite locations of highest predicted annual average ground level D/Q if milk sampling is not performed at all required locations.	Monthly, when available.	Gamma isotopic ⁽⁵⁾ and I-131 analyses, monthly, when samples are collected
	One sample of each of the similar broad leaf vegetation grown 15 to 30 km distant in the least prevalent wind direction ⁽³⁾ if milk sampling is not performed at all required locations.	Monthly, when available.	Gamma isotopic ⁽⁵⁾ and I-131 analyses, monthly, when samples are collected

* Reports from 3 additional airborne radioiodine sample locations may be supplemented for broad leaf vegetation samples.

TABLE 3.12-1 (Continued)

TABLE NOTATIONS

- (1) For each sample location required by Table 3.12-1, specific parameters of distance and direction sector from the centerline of one reactor, and additional description where pertinent, are provided in information maintained current in the results of the annual Land Use Census. Deviations are permitted from the required sampling schedule if specimens are unobtainable due to circumstances such as hazardous conditions, seasonal unavailability, and malfunction of automatic sampling equipment. If specimens are unobtainable due to sampling equipment malfunction, effort shall be made to complete corrective action prior to the end of the next sampling period. All deviations from the sampling schedule shall be documented in the Annual Radiological Environmental Operating Report pursuant to Control 6.9.1.3. It is recognized that, at times, it may not be possible or practicable to continue to obtain samples of the media of choice at the most desired location or time. In these instances suitable specific alternative media and locations may be chosen for the particular pathway in question and appropriate substitutions made within 30 days in the Radiological Environmental Monitoring Program. New sampling locations shall be listed in the results of the annual Land Use Census.
- (2) One or more instruments, such as a pressurized ion chamber, for measuring and recording dose rate continuously may be used in place of, or in addition to, integrating dosimeters. For the purposes of this table, a thermoluminescent dosimeter (TLD) is considered to be one phosphor; two or more phosphors in a packet are considered as two or more dosimeters. Film badges shall not be used as dosimeters for measuring direct radiation.
- (3) The purpose of this sample is to obtain background information. If it is not practical to establish control locations in accordance with the distance and wind direction criteria, other sites that provide valid background data may be substituted. The control sample location at 12.3 miles in the southwest sector has been evaluated and found to be an acceptable substitute sampling location.
- (4) Airborne particulate sample filters shall be analyzed for gross beta radioactivity 24 hours or more after sampling to allow for radon and thoron daughter decay. If gross beta activity in air particulate samples is greater than 10 times the yearly mean of control samples, gamma isotopic analysis shall be performed on the individual samples.
- (5) Gamma isotopic analysis means the identification and quantification of gamma-emitting radionuclides that may be attributable to the effluents from the facility.
- (6) The Reservoir shall be sampled in an area at or beyond but near the mixing zone. Also, the Reservoir shall be sampled at a distance beyond significant influence of the discharge.
- (7) Lake Granbury shall be sampled near the letdown discharge and at a distance beyond significant influence of the discharge.
- (8) Groundwater samples shall be taken when this source is tapped for drinking or irrigation purposes in areas where the hydraulic gradient or recharge properties are suitable for contamination.

TABLE 3.12-1 (Continued)

TABLE NOTATIONS (Continued)

- (9) The dose shall be calculated for the maximum organ and age group, using the methodology and parameters in Part II of the ODCM.
- (10) If harvest occurs more than once a year, sampling shall be performed during each discrete harvest. If harvest occurs continuously, sampling shall be monthly. Attention shall be paid to including samples of tuberous and root food products.

TABLE 3.12-2
REPORTING LEVELS FOR RADIOACTIVITY CONCENTRATIONS IN ENVIRONMENTAL SAMPLES

ANALYSIS	WATER (pCi/l)	AIRBORNE PARTICULATE OR GASES (pCi/m ³)	FISH (pCi/kg, wet)	MILK (pCi/l)	FOOD PRODUCTS (pCi/kg, wet)
H-3	20,000*				
Mn-54	1,000		30,000		
Fe-59	400		10,000		
Co-58	1,000		30,000		
Co-60	300		10,000		
Zn-65	300		20,000		
Zr-Nb-95	400				
I-131	2**	0.9		3	100
Cs-134	30	10	1,000	60	1,000
Cs-137	50	20	2,000	70	2,000
Ba-La-140	200			300	

(*) For drinking water samples. This is 40 CFR Part 141 value. If no drinking water pathway exists, a value of 30,000 pCi/l may be used.

(**) If no drinking water pathway exists, a value of 20 pCi/l may be used.

TABLE 4.12-1
DETECTION CAPABILITIES FOR ENVIRONMENTAL SAMPLE ANALYSIS⁽¹⁾⁽²⁾

Lower Limit of Detection (LLD)⁽³⁾

ANALYSIS	WATER (pCi/l)	AIRBORNE PARTICULATE OR GASES (pCi/m ³)	FISH (pCi/kg, wet)	MILK (pCi/l)	FOOD PRODUCTS (pCi/kg, wet)	SEDIMENT (pCi/kg, dry)
Gross Beta	4	0.01				
H-3	2000*					
Mn-54	15		130			
Fe-59	30		260			
Co -58, 60	15		130			
Zn-65	30		260			
Zr-Nb-95	15					
I-131	1**	0.07		1	60	
Cs-134	15	0.05	130	15	60	150
Cs-137	18	0.06	150	18	80	180
Ba-La-140	15			15		

* If no drinking water pathway exists, a value of 3000 pCi/l may be used.

** If no drinking water pathway exists, a value of 15 pCi/l may be used.

TABLE 4.12-1 (Continued)

TABLE NOTATIONS

- (1) The list does not mean that only these nuclides are to be considered. Other peaks that are identifiable, together with those of the above nuclides, shall also be analyzed and reported in the Annual Radiological Environmental Operating Report pursuant to Control 6.9.1.3.
- (2) Required detection capabilities for thermoluminescent dosimeters used for environmental measurements shall be in accordance with the recommendations of Regulatory Guide 4.13.
- (3) The LLD is defined, for purposes of these specifications, as the smallest concentrations of radioactive material in a sample that will yield a net count, above system background, that will be detected with 95% probability with only a 5% probability of falsely concluding that a blank observation represents a "real" signal.

$$LLD = \frac{4.66s_b}{E \cdot V \cdot Y \cdot \exp(-\lambda\Delta t) \cdot 2.22}$$

Where:

- LLD = the "a priori" lower limit of detection (picoCurie per unit mass or volume),
- s_b = Standard deviation of the background counting rate or of the counting rate of a blank sample as appropriate (counts per minute),
- E = Counting efficiency (counts per disintegration),
- V = Sample size (units of mass or volume),
- 2.22 = Number of disintegrations per minute per picoCurie,
- Y = Fractional radiochemical yield, when applicable,
- λ = Radioactive decay constant for the particular radionuclide (sec^{-1}), and
- Δt = Elapsed time between the midpoint of sample collection and the time of counting(s).

Typical values of E, V, Y, and Δt should be used in the calculation.

It should be recognized that the LLD is defined as an a priori (before the fact) limit representing the capability of a measurement system and not as an a posteriori (after the fact) limit for a particular measurement. Analyses shall be performed in such a manner that the stated LLDs will be achieved under routine conditions. Occasionally background fluctuations, unavoidable small sample sizes, the presence of interfering nuclides, or other uncontrollable circumstances may render these LLD's unachievable. In such cases, the contributing factors shall be identified and described in the Annual Radiological Environmental Operating Report pursuant to Control 6.9.1.3.

3/4.12 RADIOLOGICAL ENVIRONMENTAL MONITORING

3/4.12.2 LAND USE CENSUS

CONTROLS

3.12.2 A Land Use Census shall be conducted and shall identify within a distance of 8 km (5 miles) the location in each of the 16 meteorological sectors of the nearest milk animal, the nearest residence, and the nearest garden* of greater than 50m² (500 ft²) producing broad leaf vegetation.

APPLICABILITY: At all times.

ACTION:

- a. With a Land Use Census identifying a location(s) that yields a calculated dose or dose commitment greater than the values currently being calculated in Control 4.11.2.3, pursuant to Control 6.9.1.4, identify the new location(s) in the next Radioactive Effluent Release Report.
- b. With a Land Use Census identifying a location(s) that yields a calculated dose or dose commitment (via the same exposure pathway) 20% greater than at a location from which samples are currently being obtained in accordance with Control 3.12.1, add the new location(s) within 30 days, to the Radiological Environmental Monitoring Program. The sampling locations having the lowest calculated dose or dose commitment(s), via the same exposure pathway, may be deleted from this monitoring program after October 31 of the year in which this Land Use Census was conducted. New sampling locations shall be listed in the results of the annual Land Use Census.

SURVEILLANCE REQUIREMENTS

4.12.2 The Land Use Census shall be conducted during the growing season at least once per 12 months using that information that will provide the best results, such as by a door-to-door survey, aerial survey, or by consulting local agriculture authorities. The results of the Land Use Census shall be included in the Annual Radiological Environmental Operating Report pursuant to Control 6.9.1.3.

* Broad leaf vegetation sampling of at least three different kinds of vegetation may be performed at the SITE BOUNDARY in each of two different direction sectors with the highest predicted D/Qs in lieu of the garden census. Specifications for broad leaf vegetation sampling in Table 3.12-1, Item 4.c. shall be followed, including analysis of control samples.

3/4.12 RADIOLOGICAL ENVIRONMENTAL MONITORING

3/4.12.3 INTERLABORATORY COMPARISON PROGRAM

CONTROLS

3.12.3 Analyses shall be performed on all radioactive materials, supplied as part of an Interlaboratory Comparison Program, that correspond to samples required by Table 3.12-1.

APPLICABILITY: At all times.

ACTION:

- a. With analyses not being performed as required above, report the corrective actions taken to prevent a recurrence to the NRC in the Annual Radiological Environmental Operating Report pursuant to Control 6.9.1.3.

SURVEILLANCE REQUIREMENTS

4.12.3 The Interlaboratory Comparison Program shall be described in Part II of the ODCM. A summary of the results obtained as part of the above required Interlaboratory Comparison Program shall be included in the Annual Radiological Environmental Operating Report pursuant to Control 6.9.1.3.

BASES

INSTRUMENTATION

BASES

3/4.3.3.4 RADIOACTIVE LIQUID EFFLUENT MONITORING INSTRUMENTATION

The radioactive liquid effluent instrumentation is provided to monitor and control, as applicable, the releases of radioactive materials in liquid effluents during actual or potential releases of liquid effluents. The Alarm/Trip Setpoints for these instruments shall be calculated and adjusted in accordance with the methodology and parameters in Part II of the ODCM to ensure that the alarm/trip will occur prior to exceeding the limits of 10 CFR Part 20. The OPERABILITY and use of this instrumentation is consistent with the requirements of General Design Criteria 60, 63, and 64 of Appendix A to 10CFR50.

3/4.3.3.5 RADIOACTIVE GASEOUS EFFLUENT MONITORING INSTRUMENTATION

The radioactive gaseous effluent instrumentation is provided to monitor and control, as applicable, the releases of radioactive materials in gaseous effluents during actual or potential releases of gaseous effluents. The Alarm/Trip Setpoints for these instruments shall be calculated and adjusted in accordance with the methodology and parameters in Part II of the ODCM to ensure that the alarm/trip will occur prior to exceeding the dose rate limits of Control 3.11.2.1. The OPERABILITY and use of this instrumentation is consistent with the requirements of General Design Criteria 60, 63, and 64 of Appendix A to 10 CFR Part 50.

3/4.3.3.6 METEOROLOGICAL MONITORING INSTRUMENTATION

The OPERABILITY of the meteorological instrumentation ensures that sufficient meteorological data are available for estimating potential radiation doses to the public as a result of routine or accidental release of radioactive materials to the atmosphere. This capability is required to evaluate the need for initiating protective measures to protect the health and safety of the public and is consistent with the recommendations of the second proposed Revision 1 to Regulatory Guide 1.23, "Onsite Meteorological Programs," April 1986.

The surveillance requirements of the meteorological instrumentation are consistent with the recommendations of the second proposed Revision 1 to Reg. Guide 1.23 except for the calibration requirements for the Wind Speed and Wind Direction sensors which are replaced with calibrated sensors at least once per each 12 months. The calibration interval starts when the sensor is installed provided the sensor has been vendor calibrated within two years, and the sensor has been in proper storage up to the time of installation. These controls have been shown to meet the accuracy and data recovery recommendations of the above reference version of Reg. Guide 1.23.

INSTRUMENTATION

BASES

3/4.7.15 SEALED SOURCE CONTAMINATION

The limitations on removable contamination for sources requiring leak testing, including alpha emitters, are based on 10CFR70.39(c) limits for plutonium. This limitation will ensure that leakage from Byproduct, Source, and Special Nuclear Material sources will not exceed allowable intake values.

Sealed sources are classified into three groups according to their use, with Surveillance Requirements commensurate with the probability of damage to a source in that group. Those sources which are frequently handled are required to be tested more often than those which are not. Sealed sources which are continuously enclosed within a shielded mechanism (i.e., sealed sources within radiation monitoring or boron measuring devices) are considered to be stored and need not be tested unless they are removed from the shielded mechanism.

3/4.11 RADIOACTIVE EFFLUENTS

BASES

3/4.11.1 LIQUID EFFLUENTS

3/4.11.1.1 CONCENTRATION CONTROLS

This control is provided to ensure that the concentration of radioactive materials released in liquid waste effluents to CONTROLLED AREAS and UNRESTRICTED AREAS will be less than 10 times the concentration values specified in Appendix B, Table 2, Column 2 to 10 CFR 20.1001-20.2402. It provides operational flexibility for releasing liquid effluents in concentrations to follow the Section II.A and II.C design objectives of Appendix I to 10 CFR Part 50. This limitation provides reasonable assurance that the levels of radioactive materials in bodies of water in CONTROLLED AREAS and UNRESTRICTED AREAS will result in exposures within (1) the Section II.A design objectives of Appendix I, 10 CFR Part 50, to a MEMBER OF THE PUBLIC and (2) restrictions authorized by 10 CFR 20.1301(e). The concentration limit for the dissolved or entrained noble gases is based upon the assumption that XE-135 is the controlling radionuclide and its effluent concentration in air (submersion) was converted to an equivalent concentration in water. This control does not affect the requirement to comply with the annual limitation of 10 CFR 20.1301 (a).

This control applies to the release of radioactive materials in liquid effluents from all units at the site.

The required detection capabilities for radioactive materials in liquid waste samples are tabulated in terms of the lower limits of detection (LLDs). Detailed discussion of the LLD and other detection limits can be found in Currie, L.A., "Lower Limit of Detection Definition and Elaboration of a Proposed Position for Radiological Effluent and Environmental Measurements," NUREG/CR-4007 (September 1984), and in the HASL Procedures Manual, HASL-300.

3/4.11.1.2 DOSE

This control is provided to implement the requirements of Sections II.A, III.A and IV.A of 10CFR50, Appendix I. The Control implements the guides set forth in Section II.A of Appendix I. The ACTION statements provide the required operating flexibility and at the same time implement the guides set forth in Section IV.A of Appendix I to assure that the releases of radioactive material in liquid effluents to CONTROLLED AREAS and UNRESTRICTED AREAS will be kept "as low as is reasonably achievable." Also, for fresh water sites with drinking water supplies that can be potentially affected by plant operations, there is reasonable assurance that the operation of the facility will not result in radionuclide concentrations in the finished drinking water that are in excess of the requirements of 40CFR141. The dose calculation methodology and parameters in Part II of the ODCM implement the requirements in Section III.A of Appendix I that conformance with the guides of Appendix I be shown by calculational procedures based on models and data, such that the actual exposure of a MEMBER OF THE PUBLIC through appropriate pathways is unlikely to be substantially underestimated. The equations specified in Part II of the ODCM for calculating the doses due to the actual release rates of radioactive materials in liquid effluents are consistent with the methodology provided in Regulatory Guide 1.109, "Calculation of Annual Doses to Man from Routine Releases of Reactor Effluents for the Purpose of Evaluating Compliance with 10CFR50, Appendix I," Revision 1, October 1977 and Regulatory Guide 1.113, "Estimating Aquatic Dispersion of Effluents from Accidental and Routine Reactor Releases for the Purpose of Implementing Appendix I," April 1977.

3/4.11 RADIOACTIVE EFFLUENTS

BASES

This control applies to the release of radioactive materials in liquid effluents from each unit at the site. The liquid effluents from the shared radwaste treatment system are proportioned equally between Unit 1 and Unit 2.

3/4.11.1.3 LIQUID RADWASTE TREATMENT SYSTEM

The OPERABILITY of the Liquid Radwaste Treatment System ensures that this system will be available for use whenever liquid effluents require treatment prior to release to the environment. The requirement that the appropriate portions of this system be used when specified provides assurance that the releases of radioactive materials in liquid effluents will be kept "as low as is reasonably achievable." This control implements the requirements of 10 CFR 50.36a, General Design Criterion 60 of Appendix A to 10 CFR Part 50 and the design objective given in Section II.D of Appendix I to 10 CFR Part 50. The specified limits governing the use of appropriate portions of the Liquid Radwaste Treatment System were specified as a suitable fraction of the dose design objectives set forth in Section II.A of Appendix I, 10 CFR Part 50 for liquid effluents.

This control applies to the release of radioactive materials in liquid effluents from each unit at the site. The liquid effluents from the shared radwaste treatment system are proportioned equally between Unit 1 and Unit 2.

3/4.11.1.4 LVW POND RESIN INVENTORY

The inventory limits of the LVW Pond are based on limiting the consequences of an uncontrolled release of the pond resin inventory. The expression in Control 3.11.1.4 assumes the pond inventory is uniformly mixed, and that the pond is located in a CONTROLLED AREA as defined in 10 CFR Part 20, and that the concentration limit in Note 4 to Appendix B of 10 CFR Part 20 applies. This expression limits the total quantity of radioactive materials in resins discharged to the LVW Pond to a value such that the average concentration in the resins, calculated over the total volume of resins in the pond, will not exceed the Effluent Concentration Limits specified in 10 CFR 20, Appendix B, Table 2, Column 2. Because Control 3.11.1.1 limits the concentration of liquid effluents from other pathways to the LVW Pond to 10 times the 10 CFR 20 Effluent Concentration values, also limiting the average concentration in resins to the Effluent Concentration values will assure that the average concentration in the pond from all sources, calculated over the total volume of the pond (liquid and resins), will not exceed the limits of Control 3.11.1.1.

The batch limits for resins transferred to the LVW Pond assure that radioactive material in the slurry transferred to the Pond are "as low as is reasonably achievable" in accordance with 10 CFR 50.36a. The expression in Control 4.11.1.4 assures no batch of resins will be transferred to the Pond unless the sum of the ratios of the activity of the radionuclides to their respective concentration limitation is less than 10% of the limits established in 10 CFR 20, Appendix B.

The batch limit is arbitrarily established at 10% of the 10 CFR 20, Appendix B limits to minimize input of radioactive materials to the LVW Pond consistent with detection limits for the resin analysis. The batch limit also provides assurance that the radioactive material released is within the inventory limitation of Control 3.11.1.4.

3/4.11 RADIOACTIVE EFFLUENTS

BASES

3/4.11.2 GASEOUS EFFLUENTS

3/4.11.2.1 DOSE RATE

This control, in conjunction with Controls 3.11.2.2 and 3.11.2.3, is provided to ensure that the dose at or beyond the SITE BOUNDARY from gaseous effluents from all units on the site will be within the annual dose limits of 10CFR20 for MEMBERS OF THE PUBLIC. The specified release rate limits restrict, at all times, the corresponding gamma and beta dose rates above background to a MEMBER OF THE PUBLIC at or beyond the SITE BOUNDARY to less than or equal to 500 mrems/year to the total body or to less than or equal to 3000 mrems/year to the skin. These release rate limits also restrict, at all times, the corresponding thyroid dose rate above background to a child via the inhalation pathway to less than or equal to 1500 mrems/year. Because these dose rate limits are applied on an instantaneous basis and because of the overriding 10 CFR 50, Appendix I, cumulative dose limitations established in Controls 3.11.2.2 and 3.11.2.3, these limits provide reasonable assurance that radioactive material discharged in gaseous effluents will not result in the exposure of a MEMBER OF THE PUBLIC, either within or outside the SITE BOUNDARY, to annual average concentrations that would result in exceeding the annual total effective dose equivalent limit specified in 10 CFR 20.1301(a). For MEMBERS OF THE PUBLIC who may at times be in CONTROLLED AREAS within the SITE BOUNDARY, the occupancy factors for those MEMBERS OF THE PUBLIC will usually be sufficiently low to compensate for any increase in the atmospheric diffusion factor above that for the SITE BOUNDARY. The methodology for calculating doses for such MEMBERS OF THE PUBLIC is provided in PART II of the ODCM.

This control applies to the release of radioactive materials in gaseous effluents from all units at the site.

The required detection capabilities for radioactive materials in gaseous waste samples are tabulated in terms of the lower limits of detection (LLDs). Detailed discussion of the LLDs and other detection limits can be found in Currie, L.A., "Lower Limit of Detection Definition and Elaboration of a Proposed Position for Radiological Effluent and Environmental Measurements," NUREG/CR-4007 (September 1984), and in the HASL Procedures Manual, HASL-300.

3/4.11.2.2 DOSE - NOBLE GASES

This control is provided to implement the requirements of Sections II.B, III.A and IV.A of 10CFR50, Appendix I. The control implements the guides set forth in Section I.B of Appendix I. The ACTION statements provide the required operating flexibility and at the same time implement the guides set forth in Section IV.A of Appendix I to assure that the releases of radioactive material in gaseous effluents to CONTROLLED AREAS and UNRESTRICTED AREAS will be kept "as low as is reasonably achievable." The Surveillance Requirements implement the requirements in Section III.A of Appendix I that conformance with the guides of Appendix I be shown by calculational procedures based on models and data such that the actual exposure of a MEMBER OF THE PUBLIC through appropriate pathways is unlikely to be substantially underestimated. The dose calculation methodology and parameters established in Part II of the ODCM for calculating the doses due to the actual release rates of the radioactive noble gases in gaseous effluents are consistent with the methodology provided in Regulatory Guide 1.109, "Calculation of Annual Dose to Man from Routine Releases of Reactor Effluents for

3/4.11 RADIOACTIVE EFFLUENTS

BASES

the Purpose of Evaluating Compliance with 10CFR50, Appendix I," Revision 1, October 1977 and Regulatory Guide 1.111, "Methods for Estimating Atmospheric Transport and Dispersion of Gaseous Effluents in Routine Releases from Light-Water Cooled Reactors," Revision 1, July 1977. The ODCM equations provided for determining the air doses at or beyond the SITE BOUNDARY are based upon the historical average atmospheric conditions.

This control applies to the release of radioactive materials in gaseous effluents from each unit at the site. The gaseous effluents from the shared radwaste treatment system are proportioned equally between Unit 1 and Unit 2.

3/4.11.2.3 DOSE - IODINE-131, IODINE-133, TRITIUM, AND RADIOACTIVE MATERIAL IN PARTICULATE FORM

This control is provided to implement the requirements of Sections II.C, III.A, and IV.A of 10CFR50, Appendix I. The Controls are the guides set forth in Section II.C of Appendix I. The ACTION statements provide the required operating flexibility and at the same time implement the guides set forth in Section IV.A of Appendix I to assure that the releases of radioactive materials in gaseous effluents to CONTROLLED AREAS and UNRESTRICTED AREAS will be kept "as low as is reasonably achievable." The ODCM calculational methods specified in the Surveillance Requirements implement the requirements in Section III.A of Appendix I that conformance with the guides of Appendix I be shown by calculational procedures based on models and data such that the actual exposure of a MEMBER OF THE PUBLIC through appropriate pathways is unlikely to be substantially underestimated. The calculational methodology and parameters specified in Part II of the ODCM for calculating the doses due to the actual release rates of the subject materials are consistent with the methodology provided in Regulatory Guide 1.109, "Calculation of Annual Doses to Man from Routine Releases of Reactor Effluents for the Purpose of Evaluating Compliance with 10CFR50, Appendix I," Revision 1, October 1977 and Regulatory Guide 1.111, "Methods for Estimating Atmospheric Transport and Dispersion of Gaseous Effluents in Routine Releases from Light-Water-Cooled Reactors," Revision 1, July 1977. These equations also provide for determining the actual doses based upon the historical average atmospheric conditions. The release rate specification for Iodine-131, Iodine-133, tritium, and radionuclides in particulate form with half-lives greater than 8 days is dependent upon the existing radionuclide pathways to man in the areas at or beyond the SITE BOUNDARY. The pathways that were examined in the development of the calculations were: (1) individual inhalation of airborne radionuclides, (2) deposition of radionuclides onto green leafy vegetation with subsequent consumption by man, (3) deposition onto grassy areas where milk animals and meat-producing animals graze with consumption of the milk and meat by man, and (4) deposition on the ground with subsequent exposure of man.

This control applies to the release of radioactive materials in gaseous effluents from each unit at the site. The gaseous effluents from the shared radwaste treatment system are proportioned equally between Unit 1 and Unit 2.

3/4.11.2.4 GASEOUS RADWASTE TREATMENT SYSTEM

The OPERABILITY of the WASTE GAS HOLDUP SYSTEM and the PRIMARY PLANT SYSTEM ensures that the systems will be available for use whenever gaseous effluents require treatment prior to release to the environment. The requirement that the appropriate portions of these

3/4.11 RADIOACTIVE EFFLUENTS

BASES

systems be used, when specified, provides reasonable assurance that the releases of radioactive materials in gaseous effluents will be kept "as low as is reasonably achievable." This control implements the requirements of 10 CFR 50.36a, General Design Criterion 60 of Appendix A to 10 CFR Part 50 and the design objectives given in Section II.D of Appendix I to 10 CFR Part 50. The specified limits governing the use of appropriate portions of the systems were specified as a suitable fraction of the dose design objectives set forth in Sections II.B and II.C of Appendix I, 10 CFR Part 50, for gaseous effluents.

This control applies to the release of radioactive materials in gaseous effluents from each unit at the site. The gaseous effluents from the shared radwaste treatment system are proportioned equally between Unit 1 and Unit 2.

3/4.11 RADIOACTIVE EFFLUENTS

BASES

3/4.11.4 TOTAL DOSE

This control is provided to meet the dose limitations of 40 CFR Part 190 that have been incorporated into 10 CFR Part 20.1301(d). The control requires the preparation and submittal of a report whenever the calculated doses due to releases of radioactivity and to radiation from uranium fuel cycle sources exceed 25 mrems to the total body or any organ, except the thyroid, which shall be limited to less than or equal to 75 mrems. For sites containing up to four reactors, it is highly unlikely that the resultant dose to a MEMBER OF THE PUBLIC will exceed the dose limits of 40 CFR Part 190 if the individual reactors remain within twice the dose design objectives of Appendix I, and if direct radiation doses from the units (including outside storage tanks, etc.) are kept small. The report will describe a course of action that should result in the limitation of the annual dose to a MEMBER OF THE PUBLIC to within the 40 CFR Part 190 limits. For the purposes of the report, it may be assumed that the dose commitment to the MEMBER OF THE PUBLIC from other uranium fuel cycle sources is negligible, with the exception that dose contributions from other nuclear fuel cycle facilities at the same site or within a radius of 8 km must be considered. If the dose to any MEMBER OF THE PUBLIC is estimated to exceed the requirements of 40 CFR Part 190, the report with a request for a variance (provided the release conditions resulting in violation of 40 CFR Part 190 have not already been corrected), in accordance with the provisions of 40 CFR 190.11 and 10 CFR 20.2203(a)(4) and 20.2203(b), is considered to be a timely request and fulfills the requirements of 40 CFR Part 190 until NRC staff action is completed. The variance only relates to the limits of 40 CFR Part 190, and does not apply in any way to the other requirements for dose limitation of 10 CFR Part 20, as addressed in Controls 3.11.1.1 and 3.11.2.1. An individual is not considered a MEMBER OF THE PUBLIC during any period in which he/she is engaged in carrying out any operation that is part of the nuclear fuel cycle. Demonstration of compliance with the limits of 40 CFR Part 190 or with the design objectives of Appendix I to 10 CFR Part 50 will be considered to demonstrate compliance with the 0.1 rem limit of 10 CFR 20.1301.

3/4.12 RADIOLOGICAL ENVIRONMENTAL MONITORING

BASES

3/4.12.1 MONITORING PROGRAM

The Radiological Environmental Monitoring Program required by this control provides representative measurements of radiation and of radioactive materials in those exposure pathways and for those radionuclides that lead to the highest potential radiation exposure of MEMBERS OF THE PUBLIC resulting from the plant operation. This monitoring program implements Section IV.B.2 of Appendix I to 10 CFR Part 50 and thereby supplements the Radiological Effluent Monitoring Program by verifying that the measurable concentrations of radioactive materials and levels of radiation are not higher than expected on the basis of the effluent measurements and the modeling of the environmental exposure pathways. Guidance for this monitoring program is provided by the Radiological Assessment Branch Technical Position on Environmental Monitoring, Revision 1, November 1979. The initially specified monitoring program will be effective for at least the first 3 years of commercial operation. Following this period, program changes may be initiated based on operational experience.

The required detection capabilities for environmental sample analyses are tabulated in terms of the lower limits of detection (LLDs). The LLDs required by Table 4.12-1 are considered optimum for routine environmental measurements in industrial laboratories. It should be recognized that the LLD is defined as an a priori (before the fact) limit representing the capability of a measurement system and not as an a posteriori (after the fact) limit for a particular measurement.

Detailed discussion of the LLD, and other detection limits, can be found in Currie, L. A., "Lower Limit of Detection: Definition and Elaboration of a Proposed Position for Radiological Effluent and Environmental Measurements," NUREG/CR-4007 (September 1984), and in the HASL Procedures Manual, HASL-300.

3/4.12.2 LAND USE CENSUS

This control is provided to ensure that changes in the use of areas at or beyond the SITE BOUNDARY are identified and that modifications to the Radiological Environmental Monitoring Program are made if required by the results of this census. The best information from the door-to-door survey, from aerial survey or from consulting with local agricultural authorities shall be used. This census satisfies the requirements of Section IV.B.3 of Appendix I to 10 CFR Part 50. Restricting the census to gardens of greater than 50 m² provides assurance that significant exposure pathways via leafy vegetables will be identified and monitored since a garden of this size is the minimum required to produce the quantity (26 kg/year) of leafy vegetables assumed in Regulatory Guide 1.109 for consumption by a child. To determine this minimum garden size, the following assumptions were made: (1) 20% of the garden was used for growing broad leaf vegetation (i.e., similar to lettuce and cabbage), and (2) a vegetation yield of 2 kg/m².

3/4.12.3 INTERLABORATORY COMPARISON PROGRAM

The requirement for participation in an approved Interlaboratory Comparison Program is provided to ensure that independent checks on the precision and accuracy of the measurements of radioactive materials in environmental sample matrices are performed as part of the quality

3/4.12 RADIOLOGICAL ENVIRONMENTAL MONITORING

BASES

assurance program for environmental monitoring in order to demonstrate that the results are valid for the purposes of Section IV.B.2 of Appendix I to 10 CFR Part 50.

SECTION 5.0
DESIGN FEATURES

5.0 DESIGN FEATURES

MAP DEFINING CONTROLLED AREAS, UNRESTRICTED AREAS AND SITE BOUNDARY FOR RADIOACTIVE GASEOUS AND LIQUID EFFLUENTS

5.1.3 Information regarding radioactive gaseous and liquid effluents, which allows identification of structures and release points as well as definition of CONTROLLED AREAS, UNRESTRICTED AREAS and the SITE BOUNDARY are shown in Figure 5.1-3.

The UNRESTRICTED AREA, as shown in Figure 5.1-3, is that area beyond the SITE BOUNDARY. Access to this area is not limited or controlled by the licensee. This is consistent with the definition of UNRESTRICTED AREA given in 10 CFR 20.1003. The SITE BOUNDARY coincides with the Exclusion (fenced) Area Boundary, as defined in 10 CFR 100.3(a). For calculations performed pursuant to 10 CFR 50.36a, the concept of UNRESTRICTED AREAS, established at or beyond the SITE BOUNDARY, is utilized in the Controls to keep levels of radioactive materials in liquid and gaseous effluents as low as is reasonably achievable.

The CONTROLLED AREA, as shown in Figure 5.1-3, is that area that is inside the SITE BOUNDARY but is outside of any plant areas defined by the licensee as restricted areas, per the definition of restricted area in 10 CFR 20.1003. Access to the CONTROLLED AREA is limited or controlled by the licensee. This is consistent with the definition of CONTROLLED AREA given in 10 CFR 20.1003.

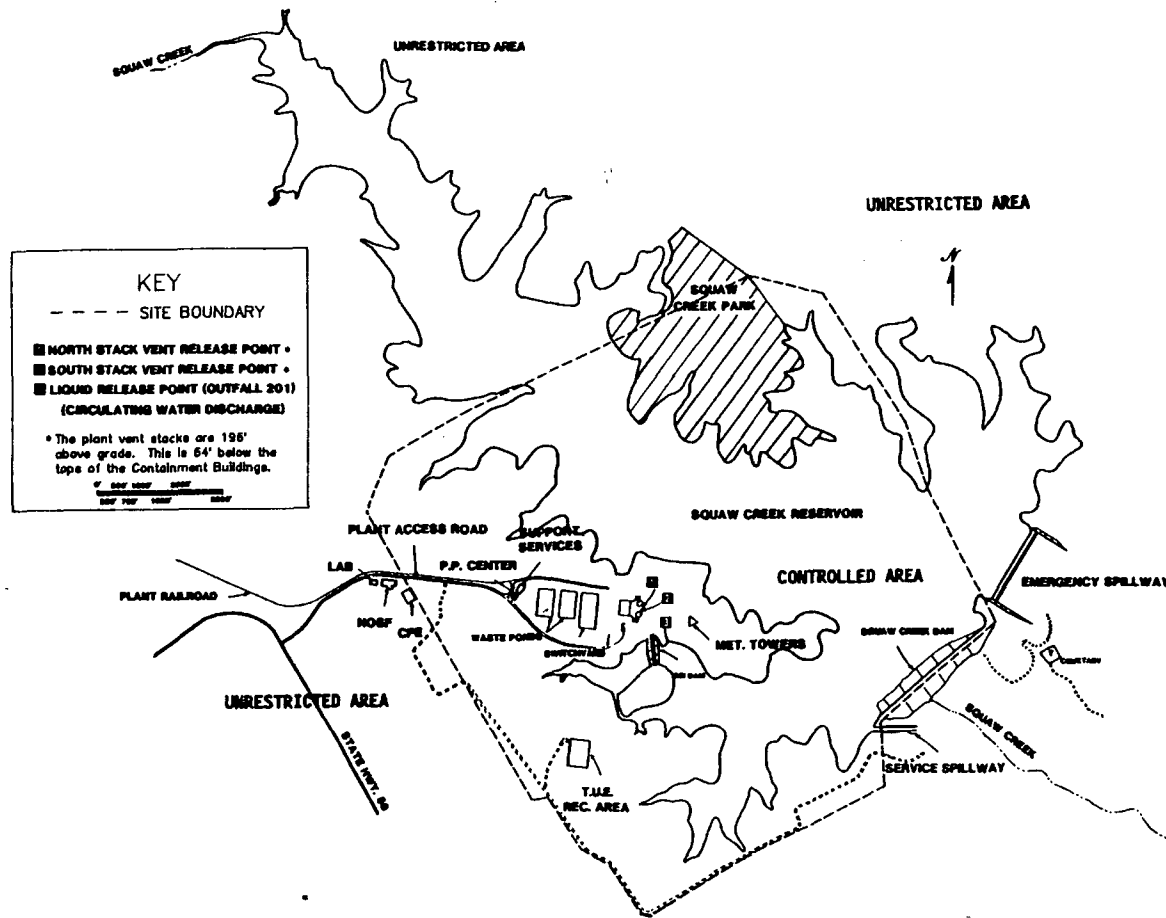

FIGURE 5.1-3
 CONTROLLED AREA, UNRESTRICTED AREA AND SITE BOUNDARY
 FOR RADIOACTIVE GASEOUS AND LIQUID EFFLUENTS

SECTION 6.0
ADMINISTRATIVE CONTROLS

ADMINISTRATIVE CONTROLS

ANNUAL RADIOLOGICAL ENVIRONMENTAL OPERATING REPORT*

6.9.1.3 A Routine Annual Radiological Environmental Operating Report covering the operation of the units during the previous calendar year shall be submitted prior to May 1 of each year.

The Annual Radiological Environmental Operating Report shall include summaries, interpretations, and an analysis of trends of the results of the radiological environmental surveillance activities for the report period, including a comparison with preoperational studies and with operational controls, as appropriate, and with previous environmental surveillance reports, and an assessment of the observed impacts of the plant operation on the environment. The report shall also include the results of the annual Land Use Census required by Control 3.12.2.

The Annual Radiological Environmental Operating Report shall include the results of analysis of all radiological environmental samples and of all environmental radiation measurements taken during the period pursuant to the locations listed and maintained current in the results of the annual Land Use Census, as well as summarized and tabulated results of these analyses and measurements in the format of the table in the Radiological Assessment Branch Technical Position, Revision 1, November 1979. In the event that some individual results are not available for inclusion with the report, the report shall be submitted noting and explaining the reasons for the missing results. The missing data shall be submitted as soon as possible in a supplementary report.

The Annual Radiological Environmental Operating Report shall also include the following: a summary description of the Radiological Environmental Monitoring Program; at least two legible maps** covering all sampling locations keyed to a table giving distances and directions from the centerline of one reactor; the results of participation in the Interlaboratory Comparison Program and the corrective action taken if the specified program is not being performed as required by Control 3.12.3; reasons for not conducting the Radiological Environmental Monitoring Program as required by Control 3.12.1, and discussion of all deviations from the sampling schedule of Table 3.12-1; discussion of environmental sample measurements that exceed the reporting levels of Table 3.12-1; and discussion of all analyses in which the LLD required by Table 4.12-1 was not achievable.

* A single submittal may be made for both units.

** One map shall cover stations near the SITE BOUNDARY; a second shall include the more distant stations. Maps are included in the results of the annual Land Use Census.

ADMINISTRATIVE CONTROLS

RADIOACTIVE EFFLUENT RELEASE REPORT*

6.9.1.4 A routine Radioactive Effluent Release Report covering the operation of the units during the previous year of operation shall be submitted prior to May 1 of each year. The period of the first report shall begin with the date of initial criticality.

The Radioactive Effluent Release Report shall include a summary of the quantities of radioactive liquid and gaseous effluents and solid waste released from the unit as outlined in Regulatory Guide 1.21, "Measuring, Evaluating, and Reporting Radioactivity in Solid Wastes and Releases of Radioactive Materials in Liquid and Gaseous Effluents from Light-Water-Cooled Nuclear Power Plants," Revision 1, June 1974, with data summarized on a quarterly basis following the format of Appendix B thereof. For solid wastes, the format for Table 3 in Appendix B shall be supplemented with three additional categories: class of solid wastes (as defined by 10 CFR Part 61), type of container (e.g., LSA, Type A, Type B, Large Quantity) and SOLIDIFICATION agent or absorbent (e.g., cement, urea formaldehyde).

The Radioactive Effluent Release Report shall include an annual summary of hourly meteorological data collected over the previous year. This annual summary may be either in the form of an hour-by-hour listing on magnetic tape of wind speed, wind direction, atmospheric stability, and precipitation (if measured), or in the form of joint frequency distributions of wind speed, wind direction, and atmospheric stability.** This same report shall include an assessment of the radiation doses due to the radioactive liquid and gaseous effluents released from the unit or station during the previous calendar year. This same report shall also include an assessment of the radiation doses from radioactive liquid and gaseous effluents to MEMBERS OF THE PUBLIC due to their activities inside the SITE BOUNDARY (Figure 5.1-3) during the report period. All assumptions used in making these assessments, i.e., specific activity, exposure time, and location, shall be included in these reports. Historical average meteorological conditions or the meteorological conditions concurrent with the time of release of radioactive materials in gaseous effluents, as determined by sampling frequency and measurement, shall be used for determining the gaseous pathway doses. The assessment of radiation doses shall be performed in accordance with the methodology and parameters in Part II of the OFFSITE DOSE CALCULATION MANUAL (ODCM).

The Radioactive Effluent Release Report shall also include an assessment of radiation doses to the likely most exposed MEMBER OF THE PUBLIC from reactor releases and other nearby uranium fuel cycle sources, including doses from primary effluent pathways and direct radiation, for the previous calendar year to show conformance with 40 CFR Part 190, "Environmental Radiation Protection Standards for Nuclear Power Operation." Acceptable methods for calculating the dose contribution from liquid and gaseous effluents are given in Regulatory Guide 1.109, Rev. 8, October 1977.

* A single submittal may be made for both units. The submittal should combine those sections that are common to both units at the station.

** In lieu of submission with the Radioactive Effluent Release Report, the licensee has the option of retaining this summary of required meteorological data on site in a file that shall be provided to the NRC upon request.

ADMINISTRATIVE CONTROLS

RADIOACTIVE EFFLUENT RELEASE REPORT (Continued)

The Radioactive Effluent Release Report shall include a list and description of unplanned releases, from the site to CONTROLLED AREAS and UNRESTRICTED AREAS, of radioactive materials in gaseous and liquid effluents made during the reporting period.

The Radioactive Effluent Release Report shall include a listing of new locations for dose calculations and/or environmental monitoring identified by the Land Use Census pursuant to Control 3.12.2.

The Radioactive Effluent Release Report shall also include the following: an explanation as to why the inoperability of liquid or gaseous effluent monitoring instrumentation was not corrected within the time specified in Controls 3.3.3.4 or 3.3.3.5, respectively; and a description of the events leading to liquid holdup tanks or gas storage tanks exceeding the Technical Specification limits.

6.14 OFFSITE DOSE CALCULATION MANUAL (ODCM)

Changes to the ODCM:

- a. Shall be documented and records of reviews performed shall be retained as required FSAR Section 17.2.17.1. This documentation shall contain:
 - 1) Sufficient information to support the change together with the appropriate analyses or evaluations justifying the change(s) and
 - 2) A determination that the change will maintain the level of radioactive effluent control required by 10 CFR 20.1302, 40 CFR Part 190, 10 CFR 50.36a, and Appendix I to 10 CFR Part 50 and not adversely impact the accuracy or reliability of effluent, dose, or setpoint calculations.
- b. Shall become effective after review and acceptance by the SORC and the approval of the Vice President of Nuclear Operations.
- c. Shall be submitted to the Commission in the form of a complete, legible copy of the entire ODCM as a part of or concurrent with the Radioactive Effluent Release Report for the period of the report in which any change to the ODCM was made. Each change shall be identified by markings in the margin of the affected pages, clearly indicating the area of the page that was changed, and shall indicate the date (e.g., month/year) the change was implemented.

PART II
CALCULATIONAL METHODOLOGIES

SECTION 1.0

LIQUID EFFLUENTS

The Comanche Peak Steam Electric Station (CPSES) is a 2-unit nuclear generating facility. Each unit is a 1150 MWe, 4-loop, Westinghouse PWR. The units share a common primary liquid radwaste processing system. CPSES is located on Squaw Creek Reservoir (SCR), which serves as the point of supply and discharge for the plant circulating water. Radioactive liquid effluent releases from the primary radwaste processing system are batch type releases, from the Plant Effluent Tanks (PET), Laundry Holdup & Monitor Tanks (LHMT) and Waste Monitor Tanks (WMT), discharged to SCR via the Circulating Water Discharge Tunnel. Potentially radioactive liquid effluent releases from secondary systems include a continuous release from the Turbine Building Sumps (TB Sump), the Unit 1 and Unit 2 Component Cooling Water Drain Tanks (CCWDT), Auxiliary Building Sumps 3 and 11, and the Unit 1 and Unit 2 Diesel Generator Sumps 1, 2, 3 and 4, and batch releases from the Condensate Polisher Backwash Recovery Tanks (CPBWRT). These secondary pathways from each unit are normally discharged to the common Low Volume Waste (LVW) Pond for chemical treatment. The LVW Pond normally discharges to SCR via the circulating Water Discharge Tunnel. Alternatively, secondary waste streams may be routed to the common Waste Water Holdup Tanks (WWHT). The WWHTs may be released on a batch basis to the LVW Pond or to SCR via the Circulating Water Discharge Tunnel, depending on the levels of radioactivity present. Table 4.11-1 of Part I of this document requires that secondary waste streams be diverted to the WWHT's if radioactivity is present in the waste stream in concentrations that exceed 10 times the limits of 10 CFR 20, Appendix B, Table 2, Column 2. Also, releases from the Station Service Water (SSW) System are monitored for radioactivity, although no significant releases of radioactivity are expected from this pathway. Sampling and analysis requirements for all release sources are given in Part I, Table 4.11-1. All batch release sources are isolated and thoroughly mixed by mechanical mixing or recirculating the tank contents, prior to sampling, to assure representative sampling. The recirculation or mixing times necessary to assure representative sampling shall be specified in station procedures.

A summary of all liquid effluent release sources, volumes, flow rates, and associated radiation monitors is shown in Table 1.1. A flow diagram of all liquid effluent discharge pathways is shown in Figure 1.1.

The liquid effluent radiation monitors shown in Figure 1.1 are part of the plant Digital Radiation Monitoring System (DRMS) supplied by Sorrento Electronics (formerly General Atomics). Since the DRMS monitors provide a digital output, they may be calibrated to read out in the appropriate engineering units (i.e., uCi/ml). The conversion factor for detector output from counts per minute to uCi/ml is determined in the calibration process and input into the database for the monitor microprocessor.

1.1 10 CFR 20 AND RADIOLOGICAL EFFLUENT CONTROL 3/4.11.1.1 COMPLIANCE

To demonstrate compliance with 10 CFR 20.1301, ODCM Radiological Effluent Control 3/4.11.1.1 requires that the concentration of radioactive material released in liquid effluents to CONTROLLED AREAS and UNRESTRICTED AREAS be limited to 10 times the concentrations specified in 10 CFR 20, Appendix B, Table 2, Column 2, for radionuclides other than dissolved or entrained noble gases, and to 2E-4 uCi/ml for dissolved or entrained noble gases. 10 CFR 20 compliance is checked for all discharges to SCR via the Circulating Water Discharge Tunnel listed in Table 1.1. Because the LVW

Pond is located in a CONTROLLED AREA, discharges to the LVW Pond are also checked for 10 CFR 20 compliance. If radioactive materials are present in the LVW Pond discharge in concentrations that exceed 10% of the limits of 10 CFR 20, Appendix B, Table 2, Column 2, then all inputs to the LVW Pond are sampled and checked for compliance with 10 CFR 20. The following methodology is used to determine compliance with these limits.

1.1.1 Isotopic Concentration of the Waste Tank

Determine the isotopic concentration in waste stream to be released:

$$\sum_i C_i = \sum_g C_g + (C_a + C_s + C_t + C_{Fe}) \quad [\text{Eq. 1-1}]$$

Where: $\sum_i C_i$	=	Sum of the concentrations of each radionuclide, i, in the release (uCi/ml),
$\sum_g C_g$	=	Sum of the concentrations of each measured, gamma emitter, g, (uCi/ml) as required by Radiological Effluent Control 3/4.11.1.1, Table 4.11-1.
C_a	=	Concentration of alpha emitters as measured in the most recent composite sample (uCi/ml) required by Radiological Effluent Control 3/4.11.1.1, Table 4.11-1. (Sample analyzed for gross alpha only),
C_s	=	Concentration of ^{89}Sr and ^{90}Sr as measured in the most recent composite sample (uCi/ml) required by Radiological Effluent Control 3/4.11.1.1, Table 4.11-1,
C_t	=	Concentration of ^3H as measured in the most recent composite sample (uCi/ml) required by Radiological Effluent Control 3/4.11.1.1, Table 4.11-1, and
C_{Fe}	=	Concentration of ^{55}Fe as measured in the most recent composite sample (uCi/ml) required by Radiological Effluent Control 3/4.11.1.1, Table 4.11-1.

1.1.2 Effluent Flow Rate (f)

The maximum effluent discharge flow rates for each release source are shown in Table 1.1. For pre-release calculations, the maximum effluent flow rate is normally used. For post-release calculations, the average effluent flow rate during the release may be used. When the maximum effluent flow rate is used for pre-release calculations, no setpoint is required for the flow measuring device for the effluent release line. If a lower effluent flow rate is used in pre-release calculations, a flow measuring device setpoint shall be established to ensure that the ratio of the Required Dilution Factor (RDF) to the Actual Dilution Factor (ADF) is maintained less than or equal to 1.0, as discussed in Section 1.1.6. ADF and RDF are defined in Section 1.1.4 and 1.1.5, respectively.

1.1.3 Dilution of Liquid Effluents

a. Discharges to SCR via Circulating Water Discharge Tunnel

Since liquid effluents from the radwaste treatment system, Waste Water Holdup Tanks and the LVW Pond are mixed with Circulating water prior to being discharged to Squaw Creek Reservoir, compliance with 10 CFR 20 is a function of the Circulating water flow rate. The maximum Circulating water flow rate per plant is 1.1 million gpm. This is determined from the Ingersoll-Rand pump curves (Fig. 1.2) which indicate a flow rate per pump of 275,000 gpm. The actual Circulating water dilution flow is given by:

$$F(\text{diluting flow}) = (275,000 \text{ gpm/pump}) \times (\# \text{ of pumps}) \times 0.9 \quad [\text{Eq. 1-2}]$$

Where: 0.9 = Safety Factor to compensate for flow fluctuations from the rate predicted by the Circulating water pump curves (Fig. 1.2).

As an additional consideration, the available dilution flow for any release may be corrected to allow for simultaneous releases from the Radwaste Processing System, a Waste Water Holdup Tank, and/or the LVW Pond (i.e., a radwaste system tank, a Waste Water Holdup Tank, and the LVW Pond may be discharged simultaneously). For simultaneous releases, the available dilution flow for any release is reduced by the required dilution flow for any other concurrent releases. Also, the reservoir into which the diluted radwaste flows may build up a concentration of radioactive isotopes. It is therefore necessary to account for recirculation of previously discharged radionuclides. This is accomplished as follows:

$$F' = F(1 - \sum_i (C'_i / 10ECL_i)) \quad [\text{Eq. 1-3}]$$

Where: F' = Adjusted Circulating Water Flow Rate

C'_i = Maximum concentration of radionuclide i in Squaw Creek Reservoir ($\mu\text{Ci/ml}$) as measured in the analysis of the monthly samples of the reservoir required by Radiological Effluent Control 3/4.12.1, Table 3.12.1. Sample locations are listed and maintained current in the results of the annual Land Use Census.

ECL_i = Effluent Concentration Limit of radionuclide i , from 10CFR20, Appendix B, Table 2, Column 2

F = $(275,000 \text{ gpm/pump}) \times (\# \text{ or pumps}) \times 0.9$

NOTE: If C'_i is less than LLD then $F' = F$ and no adjusted flow rate need be considered in the calculation of ADF. The LLD values used for this determination shall be the LLD values for water given in Radiological Effluent Control 3/4.12.1, Table 4.12-1.

b. Discharges to the LVW Pond

Secondary release sources are discharged directly to the LVW Pond with no dilution (i.e., F=0).

1.1.4 Actual Dilution Factor (ADF)

ADF is the ratio of the effluent flow rate plus the Circulating water flow rate divided by the effluent flow rate.

$$ADF = (f + F)/f \quad \text{[Eq. 1-4]}$$

Where: f = Effluent flow rate (gpm)

F = Dilution flow rate (gpm)

NOTE: If radioactivity is detected in the Reservoir, an adjusted Circulating water flow rate, F', shall be used in place of F in the calculation of ADF. See Section 1.1.3 for the calculation of F' (Eq. 1-3). Also, if simultaneous releases are occurring, the available dilution flow shall be reduced by the required dilution flow for any other concurrent release.

1.1.5 Required Dilution Factor (RDF)

The required dilution factor ensures that the limits of Control 3/4.11.1.1 (i.e., 10 times the effluent concentrations expressed in 10CFR20, Appendix B, Table 2, Column 2, and a total concentration of dissolved or entrained noble gases of 2×10^{-4} uCi/ml) are not exceeded during a discharge. The required dilution factor includes a safety factor of 2 to provide a margin of assurance that the instantaneous concentration limits are not exceeded.

$$\begin{aligned} RDF &= (\sum_i (C_i/10ECL_i)) \times SF \\ &= (\sum_g (C_g/10ECL_g) + (C_a/10ECL_a + C_s/10ECL_s + \\ &\quad C_t/10ECL_t + C_{Fe}/10ECL_{Fe})) \times SF \end{aligned} \quad \text{[Eq. 1-5]}$$

Where: ECL_i = Effluent Concentration Limit of radionuclide i, from 10CFR20, Appendix B, Table 2, Column 2

SF = Safety Factor of 2.

All other variables and subscripts are previously defined.

NOTE: If RDF is less than 1, the release meets discharge limits without dilution. For conservatism, set RDF equal to 1.0. The maximum value for the high alarm setpoint for detector XRE-5253 would then be calculated in accordance with the equation for C_{lw} in Section 1.2.1.

1.1.6 10 CFR 20 Compliance

Compliance with 10 CFR 20 is demonstrated if the Actual Dilution Factor (ADF) is greater than the Required Dilution Factor (RDF), or:

$$\frac{RDF}{ADF} < 1.0 \quad [Eq. 1-6]$$

1.2 RADIATION MONITOR ALARM SETPOINTS

1.2.1 Primary Liquid Effluent Monitor XRE-5253

To ensure that releases from the primary radwaste processing system do not exceed 10 times the 10 CFR 20, Appendix B, Table 2, Column 2 limits at the point of release to the CONTROLLED AREA or UNRESTRICTED AREA, a radiation detector (XRE-5253) monitors discharges to the Circulating Water Discharge Tunnel. XRV-5253 is the discharge isolation valve controlled by XRE-5253. The isolation valve shuts automatically if the detector alarms on high radiation or a detector operation failure occurs. It should be noted that the liquid effluent monitor setpoint values determined using the methodology from this section will be regarded as upper bounds for the actual setpoint adjustments. That is, setpoints may be established at values lower than the calculated values, if desired. Further, if the calculated value should exceed the maximum range of the monitor, the setpoint shall be adjusted to a value that falls within the normal operating range of the monitor.

Since the radiation monitor XRE-5253 is a gamma sensitive device, the monitor setpoint value shall be set based on the gamma radionuclides present in the waste stream. Therefore, a Required Dilution Factor gamma (RDF_g) must be determined before the setpoint can be calculated.

$$RDF_g = \sum (C_g/10ECL_g) \times SF \quad [Eq. 1-6a]$$

- Where: RDF_g = The required dilution factor (gamma) corresponding to the gamma concentration in the undiluted waste stream ensuring that 10 times the effluent concentration limits in 10CFR20, Appendix B, Table 2, Column 2 are not exceeded at the point of release during a discharge. If RDF_g is less than 1, set RDF_g equal to 1.0.
- SF = A required safety factor of 2 is used to account for the presence of Tritium, composited Alpha emitters, Fe-55, Sr-89 and Sr-90 values which are undetectable by this monitor and are at or near equilibrium and/or not expected to change rapidly under most plant conditions and statistical errors of measurement.

The monitor XRE-5253 setpoint is determined using the following calculation:

$$C_{lw} = (ADF/RDF_g) \times \sum_g C_g \quad [\text{Eq. 1-7}]$$

- Where: C_{lw} = The liquid waste effluent monitor alarm setpoint. This corresponds to the gamma concentration in the undiluted waste stream which after dilution would result in a release at the limits of Control 3.11.1.1.

All other variables are as previously defined.

When considering the mixture of nuclides in the liquid effluent stream in terms of detector sensitivity, the most probable nuclides present would be those referenced in Radiological Effluent Control 3/4.11.1.1, Table 4.11-1, Table Notation 2. Figure 1.3 is a representative energy spectrum response for the RD-33 type detector used in XRE-5253. This curve illustrates that for any given mixture of the most probable gamma emitting nuclides present, the conversion factor between counts per minute and microcuries per milliliter remains relatively constant. In fact between ^{137}Cs and ^{60}Co , the total change in sensitivity is approximately 7%. Because this is well within the accuracy of measurement, there is no need to change the software sensitivity for given varied effluent concentrations. However, should the concentration of previously unexpected nuclides become significant, further evaluation would be required.

1.2.2 Turbine Building Sump Effluent Radiation Monitor 1RE-5100 and 2RE-5100

The purpose of the turbine building sump monitor (1RE-5100 and 2RE-5100) is to monitor turbine building sump discharges and divert this discharge from the Low Volume Waste Pond to the Waste Water Holdup Tanks if radioactivity is detected. Because the only sources of water to the turbine building sump are from the secondary steam system, activity is expected only if a significant primary-to-secondary leak is present. Since detectable radioactivity is not normally present in the Turbine Building Sumps, the monitor setpoint should be established as close to background as practical to prevent spurious alarms and yet alarm, should an inadvertent radioactive release occur. To this end, the setpoint will be initially established at three (3) times background until further data can be collected. Then, if this setpoint is exceeded, the monitor will direct control valves to divert the turbine building sumps discharges from the LVW Pond to the Waste

Water Holdup Tanks where the effluent can then be sampled and released in a batch mode to Squaw Creek Reservoir, if required by Radiological Effluent Control 3/4.11.1.1, Table 4.11-1. When radioactive materials are detected in the Turbine Building Sumps, a setpoint then may be established for 1RE-5100 or 2RE-5100 using the methodology in Section 1.2.1 to ensure that the limits of Control 3.11.1.1 are not exceeded in discharges to the LVW Pond.

1.2.3 Station Service Water (SSW) Effluent Radiation Monitors 1RE-4269/4270 and 2RE-4269/4270

The concentration of byproduct radioactive materials released from plant operations to the station service water (SSW) effluent lines normally is expected to be insignificant. However, because the SSW effluent has no additional dilution prior to its release into Squaw Creek Reservoir, it is important that this stream's process radiation monitors be optimized to detect any potential radioactive release of CPSES radioactive materials which could leak via this pathway. Complicating this surveillance task, operational experience has shown that the SSW radiation monitors periodically detect natural radionuclides in the SSW effluent. These natural radionuclides originate from washout of radon daughter products on plant surfaces following rainfall events. The detection of natural radionuclides in the SSW effluent is consistent with the normal expected function and operable status of the SSW radiation monitors. However, if a SSW radiation monitor setpoint is exceeded and an alarm is initiated (especially during or immediately after rainfall), then it is necessary to verify if the detected radioactivity is from natural radionuclides or from plant contamination by established assessment techniques. Natural radionuclides may be verified when a SSW alert setpoint only is exceeded by sampling or by comparison to the Component Cooling Water (CCW) process radiation monitors since the source of CPSES byproduct radionuclides in the SSW would be from the CCW.

Plant procedures and operating practices provide verification of detector alert or alarm conditions. The SSW effluent radiation monitors should have alert setpoints established as close to background as practical to prevent spurious alarms and yet alarm should an inadvertent release of plant byproduct radioactive materials occur. To this end, the monitor's alert setpoint is normally established at three (3) times background. Alert setpoint alarms should be verified in accordance with plant procedures. Those alert setpoint alarms attributable to natural radionuclides should not be considered to be a plant adverse condition (i.e., release of plant contamination) and should not result in the monitor being declared inoperable.

The SSW effluent radiation monitor's alarm setpoint is set at a higher level threshold, based on operating experience, to prevent alarm by most natural radionuclide washout events. Events that result in a SSW effluent radiation monitor alarm setpoint alarm should be considered a plant adverse condition and be investigated in accordance with plant procedures and applicable Controls of Part I of the ODCM. If the SSW effluent stream becomes contaminated with plant byproduct radioactive materials, radionuclide concentrations should be determined from grab samples and a radiation monitor alarm setpoint determined as follows:

$$C_{sw} = \frac{\sum_g C_g}{DF} \quad \text{[Eq. 1-8]}$$

Where: C_{sw} = Station Service Water effluent monitor alarm setpoint

C_g = Concentration of each measured gamma emitter (g), observed in the effluent (uCi/ml)

DF = $\sum_i(C_i/10ECL_i)$ = Dilution factor required to ensure limits of Control 3/4.11.1.1 are not exceeded.

As stated above, for the SSW effluent release pathway there is no additional dilution available. Therefore, if the calculated DF is greater than 1.0, any releases occurring via this pathway will result in a violation of Radiological Effluent Control 3/4.11.1.1. If plant byproduct radioactivity is detected in the SSW effluent, doses due to releases shall be calculated in accordance with the methodology given in Section 1.3, with the near field average dilution factor, F_k , equal to 1.0.

1.2.4 Auxiliary Building to LVW Pond Radiation Monitor XRE-5251A

The purpose of the Auxiliary Building to LVW Pond monitor (XRE-5251A) is to monitor the Auxiliary Building Sumps 3 and 11, Unit 1 and Unit 2 Diesel Generator Sumps 1 and 2 and the Unit 1 and Unit 2 Component Cooling Water Drain Tanks continuous discharges and divert these discharges from the Pond to the Waste Water Holdup Tanks if radioactivity is detected. Since detectable radioactivity is not normally present in these discharges, the monitor setpoint should be established as close to background as practical to prevent spurious alarms and yet alarm should an inadvertent radioactive release occur. To this end, the setpoint will be initially established at three (3) times background until further data can be collected. Then, if this setpoint is exceeded, XRE-5251A will direct valves X-HV-WM182 and 183 to divert the discharges from the LVW Pond to the Waste Water Holdup Tanks where the effluent can then be sampled and released in a batch mode to Squaw Creek Reservoir, if required by Radiological Effluent Control 3/4.11.1.1, Table 4.11-1. When radioactive materials are detected in the discharges, a setpoint then may be established for XRE-5251A using the methodology in Section 1.2.1 to ensure that the limits of Control 3.11.1.1 are not exceeded in discharges to the LVW Pond.

1.3 DOSE CALCULATIONS FOR LIQUID EFFLUENTS

For implementation of Radiological Effluent Control 3/4.11.1.2, the dose commitment from the release of liquid effluents will be calculated at least once per 31 days and a cumulative summation of the total body and organ dose commitments will be maintained for each calendar quarter and each calendar year. Dose calculations will be performed for releases from the Plant Effluent Tanks, Waste Monitor Tanks, Laundry Holdup & Monitor Tanks, Waste Water Holdup Tanks, and the LVW Pond via the Circulating Water Tunnel at the point of discharge to Squaw Creek Reservoir. Although the LVW Pond is located in a CONTROLLED AREA, dose calculations for discharges to the LVW Pond will not be performed because there are no real pathways for exposure to members of the public. Doses for these pathways will be calculated when the LVW Pond is discharged to Squaw Creek Reservoir. The cumulative dose over the desired time period (e.g., the sum

of all doses due to releases during a 31 day period, calendar quarter, or a calendar year) will be calculated using the following equation:

$$D_T = \sum_k D_k + \sum_m D(\text{lake})_m \quad [\text{Eq. 1-9}]$$

- Where: D_T = Dose commitment to the total body or any organ due to all releases during the desired time interval from all release sources (mrem).
- D_k = Dose commitment received by the total body or any organ during the duration of release k(mrem). The equation for calculating D_k is given in Section 1.3.1 (Eq. 1-10).
- $D(\text{lake})_m$ = Dose commitment received by the total body or any organ during the desired time period, m, (normally m = 31 days) due to the buildup in the lake of previously discharged radionuclides. The equation for calculating $D(\text{lake})_m$ is given in Section 1.3.2 (Eq. 1-12).

To demonstrate compliance with the dose limits of Control 3/4.11.1.2, the calculated cumulative dose (i.e., the total dose for both units) will be compared to two times the dose limits for a unit. In other words, the dose assigned to each unit will be one-half of the total doses from all releases from the site.

1.3.1 Calculation of Dose Due to Liquid Releases

The dose commitment to the total body or any organ due to a release will be calculated using the following equation:

$$D_k = \sum_i A_i t_k C_{ik} F_k \quad [\text{Eq. 1-10}]$$

- Where: t_k = Time duration of the release k (hrs)
- C_{ik} = Isotopic concentration (uCi/ml) of radionuclide i found in the release sample for release k. Concentrations are determined primarily from gamma isotopic analysis of the liquid effluent sample. For Sr-89, SR-90, H-3, Fe-55 and alpha emitters, the last measured value will be used in the dose calculation.
- F_k = Near field average dilution factor during a liquid effluent release. This is defined as the ratio of the average undiluted liquid effluent flow rate to the average Circulating water flow rate during the release. The average liquid effluent flow rate is based on the actual average flow into the Circulating water during the release.

F_k = $\frac{\text{average undiluted liquid effluent flow rate}}{\text{circulating water flow rate}}$

$A_{i\tau}$ = Site related ingestion dose commitment factor for the total body or any organ, τ , for each identified gamma or beta emitter (mrem/hr per uCi/ml). $A_{i\tau}$ is calculated as follows:

$$A_{i\tau} = 1.14 \times 10^5 (U_w/D_w + U_f BF_i) DF_i \quad [\text{Eq. 1-11}]$$

Where: 1.14×10^5 = unit conversion factor, $\frac{\text{pCi} \cdot \text{ml} \cdot \text{yrs}}{\mu\text{Ci} \cdot \text{l} \cdot \text{hrs}}$

U_w = Adult water consumption from Squaw Creek Reservoir, 0 liters/yr for CPSES

U_f = Adult fish consumption, 21 kg/yr

BF_i = Bioaccumulation factor for radionuclide i , in fish from Table A-1, Ref. 2 (pCi/kg per pCi/l)

DF_i = Adult dose conversion factor for radionuclide i , from Table E-11, Ref. 22 (mrem/pCi ingested)

D_w = Dilution factor from the near field area within one-quarter mile of the release point to the potable water intake for the adult water consumption; 1.0 for CPSES. (unitless)

Calculated values for $A_{i\tau}$ are given in Table 1.2.

1.3.2 Calculation of Dose Due to Radionuclide Buildup in the Lake

The dose contribution from significant pathways, due to buildup of previously discharged radionuclides in the lake, must be considered in the committed dose calculation only if radioactivity is detected in the water of Squaw Creek Reservoir or in fish from Squaw Creek Reservoir. Based on the design calculations presented in the CPSES FSAR, Appendix 11A and documented in CPSES Engineering Calculation No. ME-CA-0000-3161, the significant pathways included in this calculation are fish consumption from Squaw Creek Reservoir and consumption of meat from cows drinking water from Squaw Creek. Additionally, consumption of milk from cows drinking water from Squaw Creek is included, but a CPSES site-specific consumption factor of 0 is normally used since there are no identified animals milked for human consumption along Squaw Creek. If animals milked for consumption are identified along Squaw Creek during the annual land use census, this pathway should be included in the dose calculation. Also, water from Squaw Creek Reservoir or Squaw Creek is not used as a source of drinking water, so the drinking water pathway is not included in dose calculations.

To further simplify the calculation, the dose due to consumption of meat and milk from cows drinking water from Squaw Creek is only calculated for tritium. CPSES Engineering

Calculation No. ME-CA-0000-3161 shows that tritium is the only isotope routinely released from CPSES that significantly contributes to the dose from these pathways (i.e., >95% of the total dose). The calculation does show a significant dose contribution from Ru-106 for the cow-meat pathway, but this isotope has not historically been observed in actual CPSES liquid effluent samples. The dose from the fish consumption pathway will be calculated for all measured isotopes.

The contribution to the total dose due to the buildup of radionuclides in the reservoir is determined as follows:

$$D(\text{lake})_m = 1.14 \times 10^{-4} [(\sum_i DF_i C'_{if} U_f) + DF_t C'_{tw} Q_{aw} (U_{milk} F_{mt} + U_{meat} F_{ft})] \times t \quad [\text{Eq. 1-12}]$$

Where: 1.14×10^{-4} = Units conversion factor (yr/hr).

- C'_{if} = Concentration of radionuclide i in fish sampled from Squaw Creek Reservoir from location F1 as described in the most current CPSES Land Use Census (pCi/kg).
- DF_t = Adult ingestion dose conversion factor for tritium for the organ of interest from Table E-11, Ref. 2 (mrem/pCi):
- C'_{tw} = Concentration of tritium in the reservoir. This value shall correspond to the highest concentration measured at any Squaw Creek Reservoir sample location (pCi/l).
- Q_{aw} = Consumption rate of contaminated water by a cow, 60 l/day from Table E-3, Ref. 2.
- U_{milk} = Adult milk consumption rate. A CPSES site-specific usage factor of 0 is normally used unless milk cows are identified along Squaw Creek during the annual Land Use Census. If milk cows are identified, a value of 310 l/yr from Table E-5, Ref. 82, should be used.
- F_{mt} = Stable element transfer coefficient for tritium that relates the daily intake rate of tritium by a cow to the concentration in milk, $1.0E-2$ pCi/l per pCi/day from Table E-1, Rev. 2.

- U_{meat} = Adult meat consumption rate, 110 kg/yr from Table E-5, Ref. 2.
- F_{ft} = Stable element transfer coefficient for tritium that relates the daily intake rate of tritium by a cow to the concentration in meat, 1.2E-2 pCi/kg per pCi/day.
- t = Exposure time, hrs (8760 hrs = 1 year)

All other variables are previously defined.

NOTE: This calculation is only required if activity is detected in water and/or fish in excess of the appropriate LLD values given in Radiological Effluent Control 3/4.12.1, Table 4.12-1. If the measured activity in water or fish is less than the required LLD values, the concentration for that particular pathway is assumed to be zero.

1.4 DOSE PROJECTIONS FOR LIQUID EFFLUENTS

Radiological Effluent Control 3/4.11.1.3 requires that appropriate portions of the liquid radwaste treatment system be used to reduce releases of radioactivity when the projected doses due to the liquid effluent from each reactor unit to CONTROLLED AREAS and UNRESTRICTED AREAS would exceed 0.06 mrem total body or 0.2 mrem to any organ in a 31-day period. The following calculational method is provided for performing this dose projection.

At least once every 31 days, the total dose from liquid releases for each unit for the previous three months will be divided by the number of days in the three month period and multiplied by 31. Also, this dose projection may include the estimated dose for a unit due to any anticipated unusual releases during the period for which the projection is made. If the projected dose for a unit exceeds 0.06 mrem total body or 0.2 mrem for any organ, appropriate portions of the Liquid Radwaste Treatment System shall be used to reduce radioactivity levels prior to release.

1.5 DEFINITIONS OF COMMON LIQUID EFFLUENT PARAMETERS

<u>TERM</u>	<u>DEFINITION</u>
ADF	Actual Dilution Factor (unitless). This is defined as the ratio of the effluent flow rate plus the circulating water flow rate divided by the effluent flow rate.
$A_{i\tau}$	The site related ingestion dose commitment factor to the total body or any organ, τ , for each identified gamma or beta emitter, i . (mRem/hr per uCi/ml)
BF_i	Biaccumulation factor for radionuclide, i , in fish from Reg. Guide 1.109. (pCi/kg per pCi/l)
C_a	The concentration of alpha emitters in liquid waste as measured in the analysis of the most recent monthly composite sample required by Radiological Effluent Control 3/4.11.1.1, Table 4.11-1. (uCi/ml)

<u>TERM</u>	<u>DEFINITION</u>
C_{Fe}	The concentration of ^{55}Fe in liquid waste as measured in the analysis of the most recent quarterly composite sample required by Radiological Effluent Control 3/4.11.1.1, Table 4.11-1. (uCi/ml)
c_g	The concentration of each measured gamma emitter, g, in the waste tank as measured in the analysis of the sample of each batch as required by Radiological Effluent Control 3/4.11.1.1, Table 4.11-1. (uCi/ml)
C_i	The concentrations of radionuclide, i, in the waste tank. (uCi/ml)
C'_i	The concentration of radionuclide i in the Reservoir as measured in the analysis of the monthly sample of the Reservoir required by Radiological Effluent Control 3/4.12.1, Table 3.12-1. This sample is taken at the Circulatory Water Intake Structure as indicated by location SW6 as described in the most current CPSES Land Use Census. (uCi/ml)
C'_{if}	The concentration of radionuclide i in fish sampled from the reservoir from location F1 as described in the most current CPSES Land Use Census. (pCi/kg)
C_{ik}	The isotopic concentration of radionuclide i found in the pre-release sample for batch release k. Concentrations are determined primarily from gamma isotopic analysis of the liquid effluent sample. For ^{89}Sr , ^{90}Sr , 3H , ^{55}Fe and alpha emitters, the last measured value will be used. (uCi/ml)
C'_{iw}	The maximum concentration of radionuclide i in SCR as measured in analysis of monthly samples of SCR.
C_{lw}	The liquid waste effluent monitor alarm setpoint. This corresponds to the gamma concentration in the undiluted waste stream which after dilution would result in a release at the limits of Control 3.11.1.1. (uCi/ml)
C_s	The concentration of ^{89}Sr and ^{90}Sr in liquid waste as measured in the analysis of the most recent quarterly composite sample required by Radiological Effluent Control 3/4.11.1.1, Table 4.11-1. (uCi/ml)
C_{sw}	The Station Service Water effluent monitor alarm setpoint. (uCi/ml).
C_t	The concentration of 3H in liquid waste as measured in the analysis of the most recent monthly composite sample required by Radiological Effluent Control 3/4.11.1.1, Table 4.11-1. (uCi/ml)
DF_i	Adult dose conversion factor for radionuclide, i, from Reg. Guide 1.109. (mrem/pCi ingested)
D_k	The dose commitment received by the total body or any organ during the duration of batch release k of liquid effluents. (mRem)
$D(lake)_m$	The dose commitment received by the total body or any organ during a desired time period, m, due to the buildup in the lake of previously discharged radionuclides. (mRem)
D_T	The total dose commitment to the total body or any organ due to all releases of liquid effluents during a desired time interval. (mRem)

<u>TERM</u>	<u>DEFINITION</u>
D_w	Dilution factor, from the near field area within 1/4 mile of the release point to the potable water intake for adult water consumption, 1.0 for CPSES. (unitless)
f	Effluent flow rate. (gpm)
F	Circulating water flow rate (or dilution flow rate). (gpm)
F'	Adjusted Circulating water flow rate to account for buildup of radionuclides in the Circulating water due to previous releases. (gpm)
F_k	The near field average dilution factor during a liquid effluent release (unitless). This is defined as the ratio of the average undiluted liquid waste flow to the average Circulating water flow during the release.
ECL_a	Effluent Concentration Limit* of a mixture of unidentified alpha emitters. (uCi/ml)
ECL_{Fe}	Effluent Concentration Limit* of ^{55}Fe . (uCi/ml)
ECL_g	Effluent Concentration Limit* of each identified gamma emitter, g. (uCi/ml)
ECL_i	Effluent Concentration Limit* of radionuclide, i. (uCi/ml).
ECL_s	Effluent Concentration Limit* of a mixture of ^{89}Sr and ^{90}Sr . (uCi/ml)
ECL_t	Effluent Concentration Limit* of tritium (3H). (uCi/ml).
SF	Safety Factor of 2. Used in the calculation of the Required Dilution Factor (RDF) for liquid releases to provide a margin of assurance that the instantaneous concentration limits are not exceeded.
RDF	Required Dilution Factor (unitless). This is defined as the dilution factor that ensures that 10 times the effluent concentrations expressed in 10CFR20, Appendix B, Table 2, Column 2, are not exceeded at the point of release to CONTROLLED AREAS and UNRESTRICTED AREAS during a discharge.
t_k	The time duration of batch release k. (hours)
U_f	Adult fish consumption. (kg/yr)
U_w	Adult water consumption. (liters/yr)

* Effluent Concentration limits (ECL) for liquids are given in 10CFR20, Appendix B, Table 2, Column 2. A value of 2×10^{-4} uCi/ml for dissolved or entrained noble gas shall be used.

TABLE 1.1
SUMMARY OF LIQUID RELEASE PATHWAYS

1. RELEASES TO SCR VIA THE CIRC WATER DISCHARGE

Release Source	Release Type	Max Flow Rate (gpm)	Max Vol (gal)	Monitor
PET-1	Batch	100	30000	XRE-5253
PET-2	Batch	100	30000	XRE-5253
WMT-1	Batch	100	5340	XRE-5253
WMT-2	Batch	100	5340	XRE-5253
LHMT-1	Batch	100	5875	XRE-5253
LHMT-2	Batch	100	5875	XRE-5253
WWHT-1	Batch	300	30500	None
WWHT-2	Batch	300	30500	None
LVW Pond	Continuous	1600	-	None

2. RELEASES TO THE WASTE WATER MANAGEMENT SYSTEM

Release Source	Release Type	Max Flow Rate (gpm)	Max Vol (gal)	Monitor
CPBWRT-A	Batch	1550	8500	None
CPBWRT-B	Batch	1550	17000	None
WWHT-1	Batch	200	33100	None
WWHT-2	Batch	200	33100	None
TBSump2 (Unit1)	Continuous	300	-	1RE-5100
TBSump4 (Unit2)	Continuous	300	-	2RE-5100
AB Secondary*	Continuous	380	-	XRE-5251A
Temporary holdup tanks	Batch	**	**	None

** Maximum flow and volume will be determined by temporary systems design.

3. DIRECT RELEASES TO SCR (SAFE SHUTDOWN IMPOUNDMENT)

Release Source	Release Type	Max Flow Rate (gpm)	Max Vol (gal)	Monitor
Unit 1 SSW Train A	Continuous	17,000	-	1RE-4269
Unit 1 SSW Train B	Continuous	17,000	-	1RE-4270
Unit 2 SSW Train A	Continuous	17,000	-	2RE-4269
Unit 2 SSW Train B	Continuous	17,000	-	2RE-4270

NOTE:

* AB Secondary Effluents contain the following sources:

	<u>Max. Flow (gpm)</u>
Auxiliary Building Sump 3	50
Auxiliary Building Sump 11	50
Diesel Generator Sump 1 (Unit 1)	50
Diesel Generator Sump 2 (Unit 1)	50
Diesel Generator Sump 1 (Unit 2)	50
Diesel Generator Sump 2 (Unit 2)	50
CCWDT (Unit 1)	40
CCWDT (Unit 2)	40

TABLE 1.2
 SITE RELATED INGESTION DOSE COMMITMENT FACTOR A_{it}
 (mRem/hr per μ Ci/ml)

ISOTOPE	BONE	LIVER	T-BODY	THYROID	KIDNEY	LUNG	GI-LLI
H-3	0.00E+00	2.26E-01	2.26E-01	2.26E-01	2.26E-01	2.26E-01	2.26E-01
C-14	3.13E+04	6.25E+03	6.25E+03	6.25E+03	6.25E+03	6.25E+03	6.25E+03
NA-24	4.07E+02	4.07E+02	4.07E+02	4.07E+02	4.07E+02	4.07E+02	4.07E+02
P-32	4.62E+07	2.87E+06	1.79E+06	0.00E+00	0.00E+00	0.00E+00	5.20E+06
CR-51	0.00E+00	0.00E+00	1.27E+00	7.62E-01	2.80E-01	1.69E+00	3.20E+02
MN-54	0.00E+00	4.38E+03	8.35E+02	0.00E+00	1.31E+03	0.00E+00	1.34E+04
MN-56	0.00E+00	1.10E+02	1.95E+01	0.00E+00	1.40E+02	0.00E+00	3.51E+03
FE-55	6.58E+02	4.55E+02	1.06E+02	0.00E+00	0.00E+00	2.54E+02	2.61E+02
FE-59	1.04E+03	2.44E+03	9.35E+02	0.00E+00	0.00E+00	6.82E+02	8.16E+03
CO-58	0.00E+00	8.91E+01	2.00E+02	0.00E+00	0.00E+00	0.00E+00	1.81E+03
CO-60	0.00E+00	2.56E+02	5.65E+02	0.00E+00	0.00E+00	0.00E+00	4.81E+03
NI-63	3.11E+04	2.16E+03	1.05E+03	0.00E+00	0.00E+00	0.00E+00	4.50E+02
NI-65	1.26E+02	1.64E+01	7.49E+00	0.00E+00	0.00E+00	0.00E+00	4.16E+02
CU-64	0.00E+00	9.97E+00	4.68E+00	0.00E+00	2.51E+01	0.00E+00	8.49E+02
ZN-65	2.32E+04	7.37E+04	3.33E+04	0.00E+00	4.93E+04	0.00E+00	4.65E+04
ZN-69	4.93E+01	9.44E+01	6.56E+00	0.00E+00	6.13E+01	0.00E+00	1.42E+01
BR-83	0.00E+00	0.00E+00	4.05E+01	0.00E+00	0.00E+00	0.00E+00	5.82E+01
BR-84	0.00E+00	0.00E+00	5.24E+01	0.00E+00	0.00E+00	0.00E+00	4.11E-04
BR-85	0.00E+00	0.00E+00	2.15E+00	0.00E+00	0.00E+00	0.00E+00	1.01E-15
RB-86	0.00E+00	1.01E+05	4.71E+04	0.00E+00	0.00E+00	0.00E+00	2.00E+04
RB-88	0.00E+00	2.94E+02	1.56E+02	0.00E+00	0.00E+00	0.00E+00	3.93E-09
RB-89	0.00E+00	1.95E+02	1.37E+02	0.00E+00	0.00E+00	0.00E+00	1.13E-11
SR-89	2.21E+04	0.00E+00	6.35E+02	0.00E+00	0.00E+00	0.00E+00	3.55E+03
SR-90	5.47E+05	0.00E+00	1.33E+05	0.00E+00	0.00E+00	0.00E+00	1.58E+04
SR-91	4.07E+02	0.00E+00	1.64E+01	0.00E+00	0.00E+00	0.00E+00	1.94E+03
SR-92	1.54E+02	0.00E+00	6.67E+00	0.00E+00	0.00E+00	0.00E+00	3.06E+03

TABLE 1.2
 SITE RELATED INGESTION DOSE COMMITMENT FACTOR A_{it}
 (mRem/hr per μ Ci/ml)

ISOTOPE	BONE	LIVER	T-BODY	THYROID	KIDNEY	LUNG	GI-LLI
Y-90	5.77E-01	0.00E+00	1.54E-02	0.00E+00	0.00E+00	0.00E+00	6.11E+03
Y-91M	5.44E-03	0.00E+00	2.11E-04	0.00E+00	0.00E+00	0.00E+00	1.60E-02
Y-91	8.45E+00	0.00E+00	2.25E-01	0.00E+00	0.00E+00	0.00E+00	4.64E+03
Y-92	5.06E-02	0.00E+00	1.48E-03	0.00E+00	0.00E+00	0.00E+00	8.87E+02
Y-93	1.60E-01	0.00E+00	4.43E-03	0.00E+00	0.00E+00	0.00E+00	5.10E+03
ZR-95	2.40E-01	7.70E-02	5.21E-02	0.00E+00	1.21E-01	0.00E+00	2.44E+02
ZR-97	1.33E-02	2.68E-03	1.22E-03	0.00E+00	4.05E-03	0.00E+00	8.30E+02
NB-95	4.46E+02	2.49E+02	1.34E+02	0.00E+00	2.46E+02	0.00E+00	1.51E+06
MO-99	0.00E+00	1.03E+02	1.96E+01	0.00E+00	2.35E+02	0.00E+00	2.39E+02
TC-99M	8.86E-03	2.51E-02	3.20E-01	0.00E+00	3.80E-01	1.23E-02	1.48E+01
TC-101	9.13E-03	1.31E-02	1.29E-01	0.00E+00	2.37E-01	6.72E-03	3.95E-14
RU-103	4.42E+00	0.00E+00	1.91E+00	0.00E+00	1.69E+01	0.00E+00	5.16E+02
RU-105	3.69E-01	0.00E+00	1.45E-01	0.00E+00	4.76E+00	0.00E+00	2.26E+02
RU-106	6.59E+01	0.00E+00	8.33E+00	0.00E+00	1.27E+02	0.00E+00	4.27E+03
AG-110M	8.81E-01	8.13E-01	4.84E-01	0.00E+00	1.60E+00	0.00E+00	3.33E+02
TE-125M	2.57E+03	9.29E+02	3.44E+02	7.72E+02	1.04E+04	0.00E+00	1.02E+04
TE-127M	6.49E+03	2.32E+03	7.90E+02	1.66E+03	2.63E+04	0.00E+00	2.17E+04
TE-127	1.05E+02	3.78E+01	2.28E+01	7.80E+01	4.29E+02	0.00E+00	8.31E+03
TE-129M	1.10E+04	4.11E+03	1.74E+03	3.78E+03	4.60E+04	0.00E+00	5.54E+04
TE-129	3.01E+01	1.13E+01	7.32E+00	2.31E+01	1.26E+02	0.00E+00	2.27E+01
TE-131M	1.66E+03	8.11E+02	6.75E+02	1.28E+03	8.21E+03	0.00E+00	8.04E+04
TE-131	1.89E+01	7.88E+00	5.95E+00	1.55E+01	8.26E+01	0.00E+00	2.67E+00
TE-132	2.41E+03	1.56E+03	1.46E+03	1.72E+03	1.50E+04	0.00E+00	7.38E+04
I-130	2.72E+01	8.02E+01	3.17E+01	6.78E+03	1.25E+02	0.00E+00	6.90E+01
I-131	1.50E+02	2.14E+02	1.22E+02	6.99E+04	3.68E+02	0.00E+00	5.64E+01
I-132	7.29E+00	1.95E+01	6.81E+00	6.81E+02	3.10E+01	0.00E+00	3.68E+00

TABLE 1.2
 SITE RELATED INGESTION DOSE COMMITMENT FACTOR A_{it}
 (mRem/hr per μ Ci/ml)

ISOTOPE	BONE	LIVER	T-BODY	THYROID	KIDNEY	LUNG	GI-LLI
I-133	5.09E+01	8.86E+01	2.70E+01	1.30E+04	1.55E+02	0.00E+00	7.96E+01
I-134	3.80E+00	1.03E+01	3.71E+00	1.79E+02	1.65E+01	0.00E+00	9.01E-03
I-135	1.59E+01	4.16E+01	1.54E+01	2.75E+03	6.69E+01	0.00E+00	4.70E+01
CS-134	2.98E+05	7.09E+05	5.79E+05	0.00E+00	2.29E+05	7.62E+04	1.24E+04
CS-136	3.12E+04	1.23E+05	8.86E+04	0.00E+00	6.85E+04	9.39E+03	1.40E+04
CS-137	3.81E+05	5.22E+05	3.42E+05	0.00E+00	1.77E+05	5.89E+04	1.01E+04
CS-138	2.64E+02	5.22E+02	2.59E+02	0.00E+00	3.83E+02	3.78E+01	2.23E-03
BA-139	9.29E-01	6.61E-04	2.72E-02	0.00E+00	6.18E-04	3.76E-04	1.65E+00
BA-140	1.94E+02	2.45E-01	1.27E+01	0.00E+00	8.30E-02	1.39E-01	4.00E+02
BA-141	4.51E-01	3.41E-04	1.53E-02	0.00E+00	3.17E-04	1.93E-04	2.06E-10
BA-142	2.04E-01	2.09E-04	1.28E-02	0.00E+00	1.77E-04	1.19E-04	2.87E-19
LA-140	1.50E-01	7.53E-02	1.99E-02	0.00E+00	0.00E+00	0.00E+00	5.52E+03
LA-142	7.66E-03	3.16E-03	8.66E-04	0.00E+00	0.00E+00	0.00E+00	2.54E+01
CE-141	2.24E-02	1.51E-02	1.72E-03	0.00E+00	7.05E-03	0.00E+00	5.79E+01
CE-143	3.94E-03	2.91E+00	3.24E-04	0.00E+00	1.29E-03	0.00E+00	1.09E+02
CE-144	1.17E+00	4.89E-01	6.26E-02	0.00E+00	2.91E-01	0.00E+00	3.94E+02
PR-143	5.52E-01	2.21E-01	2.73E-02	0.00E+00	1.28E-01	0.00E+00	2.41E+03
PR-144	1.80E-03	7.49E-04	9.16E-05	0.00E+00	4.23E-04	0.00E+00	2.59E-10
ND-147	3.76E-01	4.35E-01	2.60E-02	0.00E+00	2.54E-01	0.00E+00	2.09E+03
W-187	2.95E+02	2.48E+02	8.65E+01	0.00E+00	0.00E+00	0.00E+00	8.11E+04
NP-239	2.86E-02	2.79E-03	1.54E-03	0.00E+00	8.74E-03	0.00E+00	5.74E+02
*SB-122	4.42E+00	8.71E-02	1.29E+00	6.01E-02	0.00E+00	2.30E+00	1.27E+03
**SB-124	5.38E+01	1.01E+00	2.12E+01	1.30E-01	0.00E+00	4.18E+01	1.52E+03
**BR-82	0.00E+00	0.00E+00	1.78E+02	0.00E+00	0.00E+00	0.00E+00	2.05E+02
**SB-125	4.27E+01	4.58E-01	8.58E+00	3.80E-02	0.00E+00	4.45E+03	3.78E+02
**SB-126	2.20E+01	4.47E-01	7.93E+00	1.35E-01	0.00E+00	1.35E+01	1.80E+03

TABLE 1.2
 SITE RELATED INGESTION DOSE COMMITMENT FACTOR A_{it}
 (mRem/hr per μ Ci/ml)

ISOTOPE	BONE	LIVER	T-BODY	THYROID	KIDNEY	LUNG	GI-LLI
**SB-127	4.94E+00	1.80E-01	1.90E+00	5.94E-02	0.00E+00	2.93E+00	1.13E+03
**LA-141	1.14E-02	3.55E-03	5.81E-04	0.00E+00	0.00E+00	0.00E+00	4.23E+02

- * The adult dose conversion factors, DF_i , for Sb-122 are not published in Reference 2. The calculation of dose conversion factors and site-related ingestion dose commitment factors for Sb-122 is documented in Reference 10.
- ** The adult dose conversion factors, DF_i , for Sb-124, Sb-125, Br-82, Sb-126, Sb-127 and La-141 are not published in Reference 2. The site-related dose commitment factors for Sb-124, Sb-125, Br-82, Sb-126, Sb-127 and La-141 were calculated using the "Adult Ingestion Dose Factors" given in Table A-3 of Reference 11, and Equation 1-11 of Part II, Section 1.3.1 of this Manual.

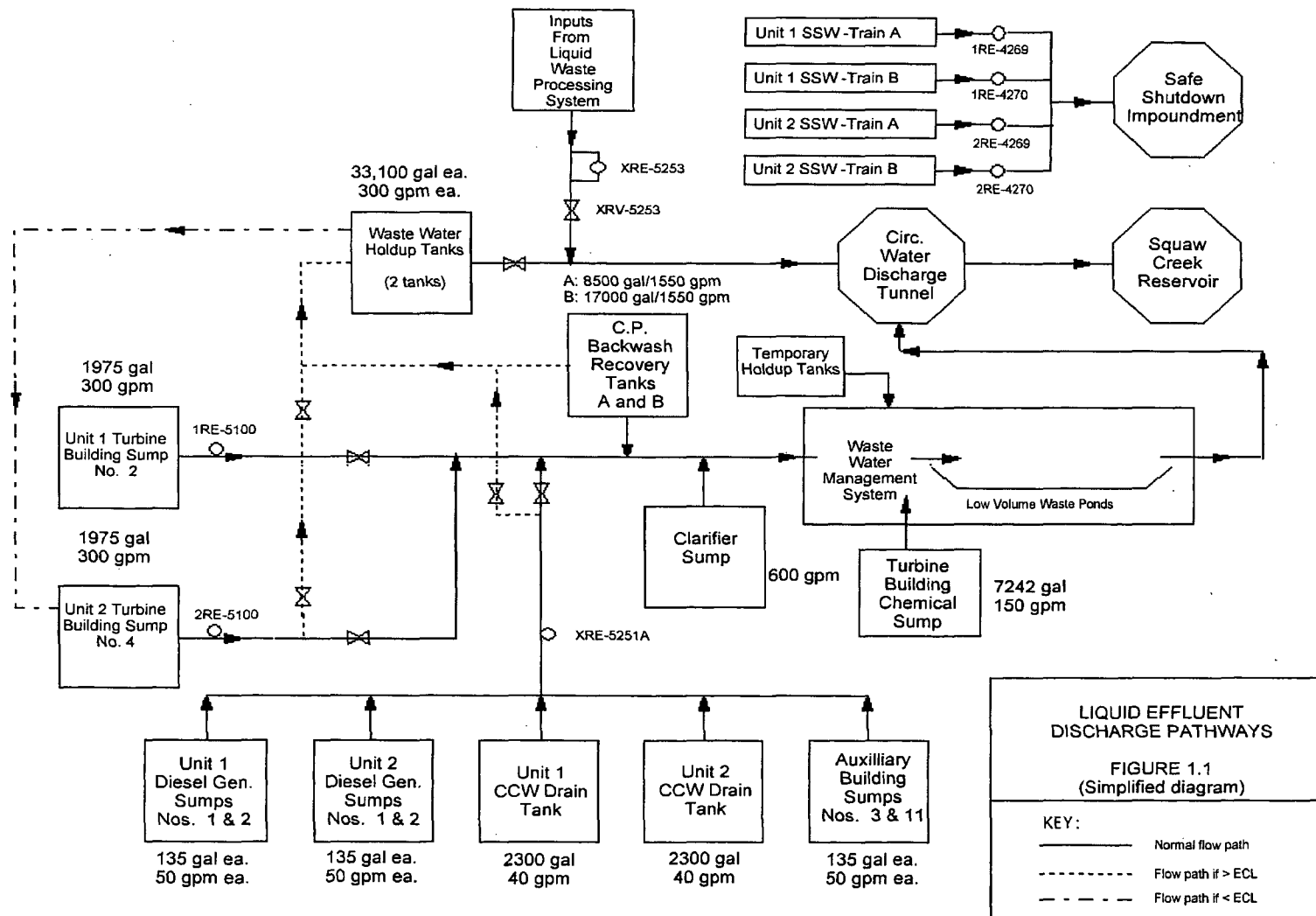

COMANCHE PEAK - UNITS 1 AND 2

PART II 1-26

01/93

DESIGN CONDITIONS

GPM 278,000 EFF 88
 TH (FT) 20 MIP 2200 GAL 1.0
 RPM 260 DRIVER 2500
 1.18 SF

FIGURE 1.2

CIRCULATING WATER PUMP CURVES

INGERSOLL-RAND CURVE # NY-3882-4

for Pump 83 APMA-1

DATE 6/28/77

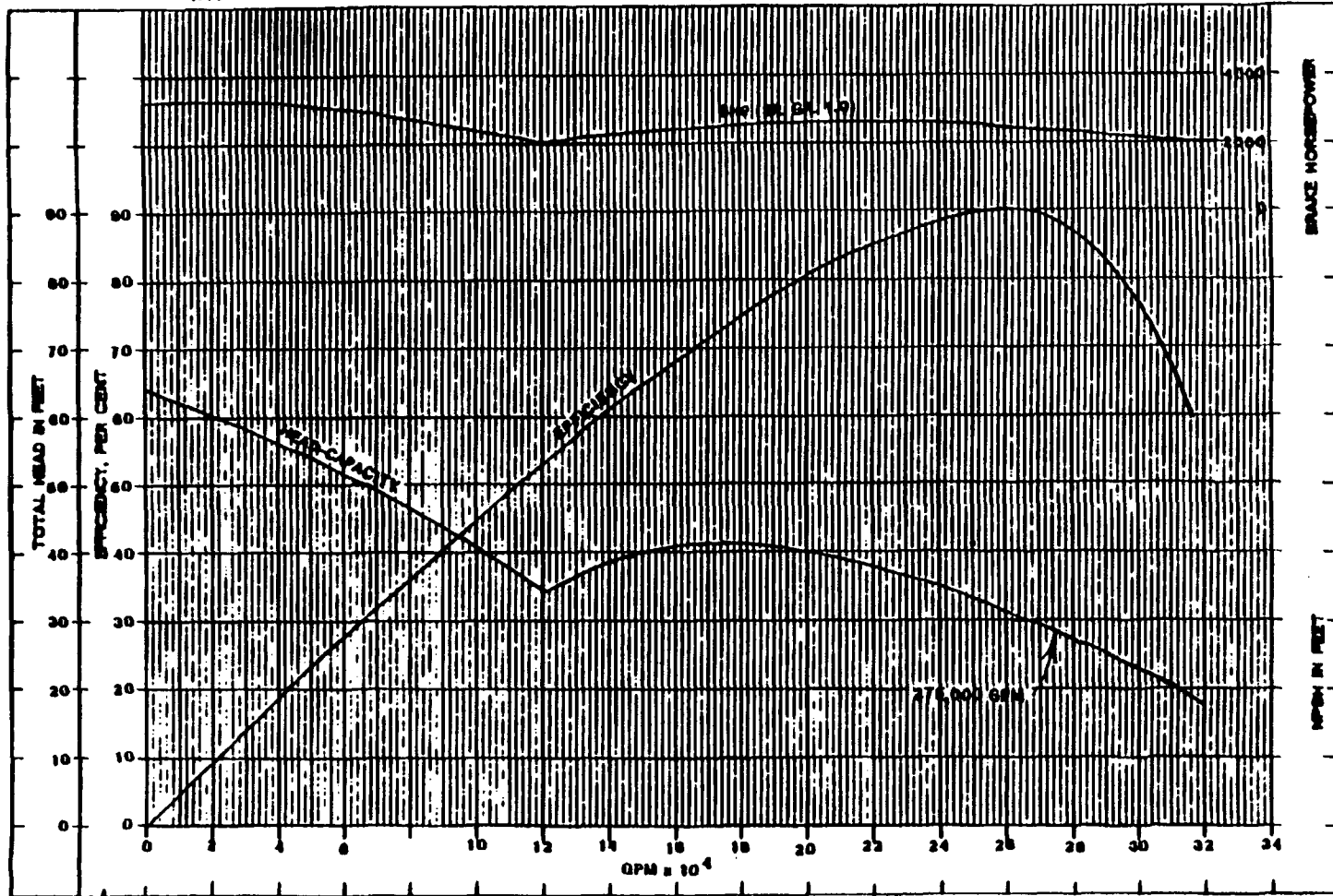

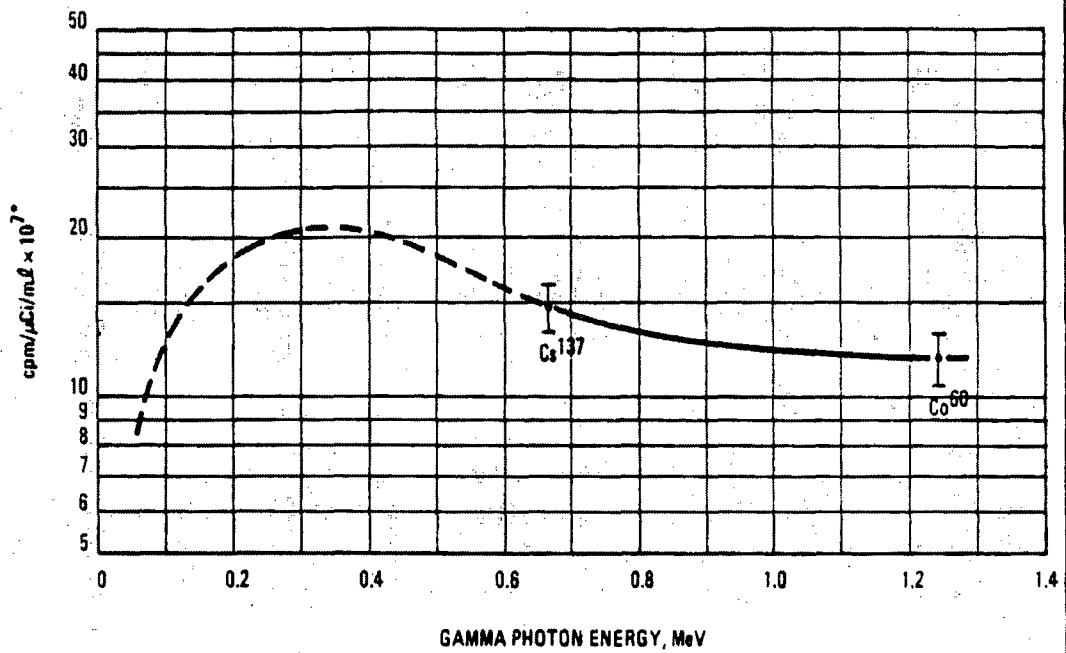

ENERGY RESPONSE TO GAMMA RADIATIONS
FOR RD-33 TYPE DETECTOR

Figure 1.3

†The broken portion of the curve was generated from early isotopic calibrations using a chamber of similar geometry.

*Based on one gamma per disintegration.

SECTION 2.0 GASEOUS EFFLUENTS

At CPSES, normal radioactive gaseous effluents are collected in a common exhaust air intake plenum, processed through charcoal and HEPA filters, and discharged to the atmosphere through the two common Plant Vent Stacks designated as Stack A and Stack B. Due to the fact that these release points are below the height of the nearest adjacent structure (i.e., containment building), all gaseous releases from these stacks are conservatively assumed to be entrained into the building wake and cavity regions, which results in a conservative ground-level release.

Routine gaseous effluent releases may occur from the Unit 1 and Unit 2 Containment Buildings (purges and vents), Waste Gas Decay Tanks (WGDT), and the plant vent stacks (continuous ventilation). The normal ventilation exhaust via the plant vent stacks is considered a continuous release. Containment Building vents for pressure relief and WGDT discharges are treated as batch releases. Because Containment Building purges are only allowed during MODES 5 and 6 and because radioactivity is discharged rapidly from the containment atmosphere during purges, the first portion (i.e., the release period during which most containment atmospheric radioactivity is discharged) of a Containment Building purge is considered a batch release. The remainder of a purge is treated as a contribution to the continuous release already occurring through the plant vent stacks.

Operating experience has shown that occasional releases may be required from Pressurizer Relief Tank (PRT) vents for depressurizing the RCS during outages, from Volume Control Tank (VCT) vents during maintenance on the Waste Gas Processing System, from the Containment Buildings during Integrated Leak Rate Tests (ILRT), and from secondary steam releases (potentially radioactive during periods of primary-to-secondary leaks). These releases occur infrequently and are treated as batch releases.

Occasional operational requirements involve handling radioactive materials in buildings outside the permanent structures that may contribute to gaseous effluents. Since these buildings are not connected to the PRIMARY PLANT VENTILATION SYSTEM, portable air sampling equipment may be used to determine effluent airborne radioactivity concentrations. Offsite dose estimates will be based on the analysis of samples collected, estimated effluent flow rates and treated as a planned continuous or batch release. The effluent discharge point is not the plant stack and the distance to the site boundary may be adjusted, if the proximity to the site boundary would significantly affect the offsite dose estimates. No automated monitoring or isolation equipment is provided, however, due to a limited source term, this pathway is expected to contribute a small fraction of the dose limits from gaseous effluents.

A summary of all gaseous effluent release points, release sources, flow rates (if applicable) and associated radiation monitors is shown in Table 2.1. A flow diagram of all Gaseous Waste Processing System discharge pathways is shown in Figure 2.1.

Each Plant Vent Stack is equipped with a Wide Range Gas Monitor (WRGM) and a Noble Gas Monitor. These monitors are part of the plant Digital Radiation Monitoring System (DRMS) supplied by Sorrento Electronics (formerly General Atomics). Since all DRMS monitors provide a digital output, they may be calibrated to read out in the appropriate engineering units (i.e., uCi/ml). The conversion factor for detector output from counts per minute to uCi/ml is determined during the calibration of each individual monitor, and is input into the data base for the monitor microprocessor.

The WRGMs are designated as monitors XRE-5570A and XRE-5570B for Stacks A and B, respectively. Each WRGM consists of a low range (10^{-7} to 10^{-1} uCi/cc), mid range (10^{-4} to 10^2 uCi/cc), and high range (10^{-1} to 10^5 uCi/cc) noble gas activity detector. The WRGMs also have an effluent release rate channel which uses inputs from the appropriate WRGM noble gas activity detectors and the plant vent stack flow rate detectors (X-FT-5570A-1/B-1) to provide an indication of noble gas release rate in uCi/sec. Alarm setpoints are established for the WRGM effluent release rate channel to fulfill the requirements of Radiological Effluent Control 3/4.3.3.5. Exceeding the WRGM effluent release rate channel high alarm setpoint also initiates automatic termination of Waste Gas Decay Tank releases.

The stack Noble Gas Monitors are designated as noble gas channels XRE-5567A and XRE-5567B for Stacks A and B, respectively. The stack noble gas channels may be used as a back-up to the WRGM when no automatic control functions are required. Therefore, a methodology is provided for calculating the noble gas monitor setpoints.

Other monitors that may be used for effluent monitoring and control are the Auxiliary Building Ventilation Duct Monitor, XRE-5701, and the Containment PIG Noble Gas Monitors, 1RE-5503 and 2RE-5503. XRE-5701 may be used to monitor Waste Gas Decay Tank releases by monitoring the Auxiliary Building Ventilation Duct. XRE-5701 also provides the automatic control function for termination of Waste Gas Decay Tank releases. 1RE-5503 and 2RE-5503 monitor the Unit 1 and Unit 2 Containment atmospheres, respectively, and provide the only automatic control function for termination of Containment vents or purges.

2.1 RADIOLOGICAL EFFLUENT CONTROL 3/4.11.2.1 COMPLIANCE

2.1.1 Dose Rates Due to Noble Gases

For implementation of Radiological Effluent Control 3/4.11.2.1.a, the dose rate to the total body and skin of an individual at the SITE BOUNDARY due to noble gases released from the site shall be calculated as follows:

a. Total Body Dose Rate Due to Noble Gases

$$D_t = \sum_v D_{tv} = \sum_v (\overline{X/Q}) \sum_i K_i Q_{iv} \quad [\text{Eq. 2-1}]$$

(noble gases)

Where: D_t = Total body dose rate at the SITE BOUNDARY due to noble gases from all release sources (mRem/yr)

D_{tv} = Total body dose rate at the SITE BOUNDARY due to noble gases from release source v (mRem/yr).

$(\overline{X/Q})$ = Highest annual average relative concentration at the SITE BOUNDARY (3.3×10^{-6} sec/m³ in the NNW sector at a distance of 1.29 miles from the plant*)

NOTE: The annual average X/Q is also used in determining setpoints for containment purge or vent as required by Technical Specification 3.3.6.

- K_i = Total body dose factor due to gamma emissions from noble gas radionuclide i from Table 2.2 (mRem/yr per uCi/m³)
 Q_{iv} = Total release rate of noble gas radionuclide i from the release source v (uCi/sec) (See C below for calculation of Q_{iv})
 v = Index over all release sources

* Reference 4, Section 2.3.5.2.

b. Skin Dose Rate Due To Noble Gases

$$D_s = \sum_v D_{sv} = \sum_v (\overline{X/Q}) \sum (L_i + 1.1M_i) Q_{iv} \quad \text{[Eq. 2-2]}$$

(noble gases)

- Where: D_s = Skin dose rate at the SITE BOUNDARY due to noble gases from all release sources. (mRem/yr)
- D_{sv} = Skin dose rate at the SITE BOUNDARY due to noble gases from release source v. (mRem/yr)
- L_i = Skin dose factor due to beta emissions from noble gas radionuclide i from Table 2.2 (mRem/yr per uCi/m³)
- 1.1 = Conversion factor of mRem skin dose per mRad air dose
- M_i = Air dose factor due to gamma emissions from noble gas radionuclide i from Table 2.2 (mRad/yr per uCi/m³)

All other terms are as previously defined.

c. Release Rate

Q_i is defined as the total release rate (uCi/sec) of radionuclide i from all release sources. Q_i is given by:

$$Q_i = \sum_v Q_{iv} = \sum_v X_{iv} F_v \quad \text{[Eq. 2-3]}$$

- Where: X_{iv} = Measured concentration of radionuclide i present in each release source v (uCi/cm³)

- F_v = Flow rate from each release source v (cm^3/sec)
 Q_{iv} = Release rate of radionuclide i from release source v (uCi/sec)
 v = Index over all release sources

2.1.2 Dose Rates Due to Radioiodines, Tritium, and Particulates

Organ dose rates due to iodine-131 and iodine-133, tritium, and all radioactive materials in particulate form with half-lives greater than eight days released from the site will be calculated to implement the requirements of Radiological Effluent Control 3/4.11.2.1.b as follows:

$$D_o = \sum_v D_{ov} = \sum_v \left(\overline{X/Q} \right) \sum_{\text{IP\&T}} P_i Q_i \quad [\text{Eq. 2-4}]$$

- Where: D_o = Total organ dose rate due to iodine-131, iodine-133, particulates with half-lives greater than eight days, and tritium from all release sources. (mrem/yr)
- D_{ov} = Organ dose rate due to iodine-131, iodine-133, particulates with half-lives greater than eight days, and tritium from release source v . (mrem/yr)
- P_i = Pathway dose rate parameter factor for radionuclide, i , (for radioiodines, particulates, and tritium) for the inhalation pathway in mRem/yr per uCi/m^3 (Table 2.3). The methodology used for determining values of P_i is given in Appendix A.
- IP&T = Iodine-131, iodine-133, particulates with half-lives greater than eight days, and tritium. These are the isotopes over which the summation function is to be performed.

All other variables are previously defined.

2.2 GASEOUS EFFLUENT MONITOR SETPOINTS

The gaseous monitor setpoint values, as determined using the methodology in the following sections, will be regarded as upper bounds for the actual setpoint adjustments. Setpoints may be established at values lower than the calculated values if desired. Further, if the calculated value should exceed the maximum range of the monitor, the setpoint shall be adjusted to a value that falls within the normal operating range of the monitor.

If a calculated setpoint is less than the measured concentration associated with the particular release pathway, no release may be made. Under such circumstances, contributing source terms shall be reduced and the setpoint recalculated.

2.2.1 Plant Vent Effluent Release Rate Monitors XRE-5570A and XRE-5570B Effluent Release Rate Channels

The WRGM effluent release rate channels monitor the release rate of radioactive materials from each plant vent stack by combining inputs from the WRGM low range noble gas activity channel ($\mu\text{Ci}/\text{cm}^3$) indication and a stack flow rate (cm^3/sec) indication (X-FT-5570A-1/B-1) to yield an effluent release rate ($\mu\text{Ci}/\text{sec}$). By establishing an alarm setpoint for this monitor, an increase in either the noble gas activity or stack flow rate will cause an alarm trip. The WRGM effluent channel also provides an automatic control function for termination of Waste Gas Decay Tank Releases. The setpoint for each plant vent effluent release rate monitor will be calculated using the following methodology:

Q_{SITE} = the lesser of:

$$Q_{\text{NG}} = \frac{500}{D_t} \times \text{SF} = 125 \frac{Q_{\text{NG}}}{D_t} \quad [\text{Eq. 2-7}]$$

OR

$$Q_{\text{NG}} = \frac{3000}{D_s} \times \text{SF} = 750 \frac{Q_{\text{NG}}}{D_s} \quad [\text{Eq. 2-6}]$$

- Where: Q_{site} = Total site noble gas release rate limit corresponding to a dose rate at or beyond the SITE BOUNDARY of 500 mrem/yr to the total body or 3000 mrem/yr to the skin. ($\mu\text{Ci}/\text{sec}$)
- Q_{NG} = \sum (noble gases) Q_i
- = Actual release rate of noble gases from all release sources as calculated from the radionuclide concentrations determined from the analysis of the appropriate samples taken in accordance with Radiological Effluent Control 3/4.11.2.1, Table 4.11-2.
- 500 = Dose rate limit to the total body of an individual at or beyond the SITE BOUNDARY due to noble gases from all release sources. (mRem/yr)
- 3000 = Dose rate limit to the skin of the body of an individual at or beyond the SITE BOUNDARY due to noble gases from all release sources. (mRem/yr)
- SF = Safety Factor of 0.5 applied to compensate for statistical fluctuations, errors of measurement, and non-uniform distribution of release activity between the stacks (unitless)

Then the release rate setpoint for each stack monitor, C_f , in uCi/sec is determined as follows:

$$C_f = Q_{\text{site}} \cdot AF \quad [\text{Eq. 2-7}]$$

Where: AF = Allocation Factor of 0.5 applied to account for releases from both plant stacks simultaneously (unitless). This factor will limit the release rate contribution from each stack to 1/2 the limit for the site.

2.2.2 Plant Vent Stack Noble Gas Activity Monitors XRE-5570A/XRE-5570B (WRGM low range noble gas activity channel) and XRE-5567A/XRE-5567B (noble gas channel)

The WRGM low range noble gas activity channels provide noble gas concentration data to the effluent release rate channels, as discussed in Section 2.2.1 above. The monitor design does not include an alarm setpoint for this channel that provides an audible alarm if the setpoint is exceeded. Therefore, setpoint adjustments are not performed for these channels. Radiological Effluent Control 3/4.3.3.5, Table 3.3-8, ACTION 36 allows for use of the stack noble gas monitors (XRE-5567A and XRE-5567B) as a backup for an inoperable WRGM effluent release rate channel when no automatic control function is required. The alarm setpoint for these channels, C_G , in uCi/cm³ is determined using the following methodology:

$$C_G = \frac{C_f}{F_{\text{PVS}}} \quad [\text{Eq. 2-8}]$$

Where: F_{PVS} = Maximum stack flow rate (cc/sec) corresponding to 115,000 cfm during normal operations and 130,000 cfm during containment purges.

2.2.3 Sampler Flow Rate Monitors (X-RFT-5570A-1/B-1)

The WRGMs are designed to sample isokinetically from the plant vent stacks. Isokinetic sample flow is maintained automatically by the monitor microprocessor. The sampler flow rate monitors are designed such that if there is a loss of sample flow, the stack monitor automatic control functions are initiated. The loss of sample flow alarm setpoints are established permanently in accordance with vendor specifications.

2.2.4 Auxiliary Building Ventilation Exhaust Monitor (XRE-5701)

Radiological Effluent Control 3/4.3.3.5, Table 3.3-8, ACTION 34, allows for the Auxiliary Building Ventilation (ABV) Duct Monitor (XRE-5701) to be used as a backup for an inoperable WRGM for monitoring Waste Gas Decay Tank (WGDT) releases. XRE-5701 monitors WGDT releases by measuring activity in the Auxiliary Building Vent Duct and providing an automatic control function for termination of WGDT releases. If required, the alarm setpoint for XRE-5701 will be calculated using the following methodology. The alarm setpoint calculation is based on the following assumption:

- (1) a waste gas decay tank release is the only batch release occurring (i.e., a containment purge or vent is not occurring at the same time).

Based on assumption (1) above, there are a maximum of three release sources that may contribute to the total release rate from the site during a WGDT release. These are the WGDT batch release, the continuous release from Stack A, and the continuous release from Stack B. Therefore, a release factor of 1/3 will be used for the ABV monitor setpoint determination. The total release rate from the site at the alarm setpoint release rate from each stack would correspond to a value of $2C_f$ uCi/sec. To determine the ABV monitor setpoint, the release rate contribution from the ABV will be limited to 1/3 of the limiting site release rate:

$$Q_{aux} = 1/3 \cdot 2C_f = 2/3 C_f \quad [\text{Eq. 2-9}]$$

Where: Q_{aux} = Limiting release rate contribution from the Auxiliary Building Vent during WGDT releases (uCi/sec)

Other terms have been previously defined.

To determine the setpoint, C_{aux} , for the ABV monitor in uCi/cc, the limiting ABV release rate is divided by the Maximum ABV flow rate:

$$C_{aux} = \frac{Q_{aux}}{F_{aux}} = \frac{2C_f}{3F_{aux}} \quad [\text{Eq. 2-10}]$$

Where: F_{aux} = Maximum ABV flow rate (cc/sec) corresponding to 106,400 cfm.

2.2.5 Containment Atmosphere Gaseous Monitors (1RE-5503 and 2RE-5503)

For implementation of Technical Specification 3.3.6, the alarm setpoint for the Containment Atmosphere Gaseous Monitor for Containment Ventilation Isolation will be calculated using the following methodology. The alarm setpoint calculation is based on the following assumption:

- (1) a purge or vent from each containment may occur simultaneously and no other batch release is occurring (i.e., a waste gas decay tank release is not occurring at the same time as a containment release).

Based on assumption (1) above, there are a maximum of four release sources that may contribute to the total release rate from the site during a containment release. These are a Unit 1 Containment release, a Unit 2 Containment release, the continuous release from Stack A, and the continuous release from Stack B. Therefore, a release factor of 1/4 will be used for the the containment monitor setpoint determination. The total release rate from the site at the alarm setpoint release rate from each stack would correspond to a value of $2C_f$ uCi/sec. To determine the containment monitor setpoint, the release rate

contribution from a containment release will be limited to 1/4 of the limiting site release rate:

$$Q_{\text{cont}} = \frac{1}{4} \cdot 2 C_f = \frac{1}{2} C_f \quad [\text{Eq. 2-11}]$$

Where: Q_{cont} = Limiting release rate contribution from a containment release (uCi/sec)

Other terms have been previously defined.

To determine the setpoint, C_{cont} , for the containment monitor in uCi/cc, the limiting containment release rate is divided by the maximum containment release flow rate:

$$C_{\text{cont}} = \frac{Q_{\text{cont}}}{F_{\text{cont}}} = \frac{C_f}{2 F_{\text{cont}}} \quad [\text{Eq. 2-12}]$$

Where: F_{cont} = Maximum containment release flow rate (cc/sec) corresponding to 750 cfm for containment vents and 30,000 cfm for containment purges.

2.3 DOSE CALCULATIONS FOR GASEOUS EFFLUENTS

The methodologies for calculating doses from gaseous effluents are given in Sections 2.3.1 and 2.3.2 below. For purposes of demonstrating compliance with the dose limits of Radiological Effluent Controls 3.11.2.2 and 3.11.2.3, the calculated cumulative doses (i.e., the total dose for both units) will be compared to two times the dose limits for a unit. In other words, the doses assigned to each unit will be one-half of the total doses from all releases from the site.

2.3.1 Dose Due to Noble Gases

For implementation of Radiological Effluent Control 3/4.11.2.2, the cumulative air dose due to noble gases to areas at and beyond the SITE BOUNDARY will be calculated at least once per 31 days and a cumulative summation of the air doses will be maintained for each calendar quarter and each calendar year. The air dose over the desired time period will be calculated as follows:

a. Air Dose Due to Gamma Emissions

D_γ = Air dose due to gamma emissions from noble gas radionuclides from all release sources. (mrad)

$$D_\gamma = 3.17 \times 10^{-8} (\overline{X/Q}) \sum M_i Q'_i \quad [\text{Eq. 2-13}]$$

(noble gases)

Where: 3.17×10^{-8} = Fraction of a year represented by one second.

Q'_i = Cumulative release of radionuclide i during the period of interest from all release sources. (uCi)
 ($Q'_i = Q_i$ (uCi/sec) x release duration (sec))

Q'_i is based on the noble gas activities in each plant vent stack and WGDT or Containment Samples required by Radiological Effluent Control 3/4.11.2.1, Table 4.11-2.

All other variables are previously defined.

b. Air Dose Due to Beta Emissions

D_β = Air dose due to beta emissions from noble gas radionuclides. (mrad)

$$D_\beta = 3.17 \times 10^{-8} (\overline{X/Q}) \sum_{\text{(noble gases)}} N_i Q'_i \quad [\text{Eq. 2-14}]$$

Where: N_i = Air dose factor due to beta emissions from noble gas radionuclide i from Table 2.2.
 (mRad/yr per uCi/m³).

All other variables are previously defined.

NOTE: If the methodology in this section is used in determining dose to an individual rather than air dose due to noble gases, substitute K_i for M_i , $(L_i + 1.1 M_i)$ for N_i , and the Annual Average X/Q values from information listed and maintained current in the results of the annual Land Use Census for the highest annual average relative concentration (X/Q) at the SITE BOUNDARY.

2.3.2 Dose Due to Radiodines, Tritium, and Particulates

For implementation of Radiological Effluent Control 3/4.11.2.3, the cumulative dose to each organ of an individual due to iodine-131, iodine-133, tritium, and particulates with half-lives greater than 8 days will be calculated at least once per 31 days and a cumulative summation of these doses will be maintained for each calendar quarter and each calendar year. The dose over the desired period will be calculated as follows:

$$D_p = \sum_{\text{Paths}} 3.17 \times 10^{-8} W' \sum_{\text{I\&PT}} R^p_{i,a,o} Q'_i \quad [\text{Eq. 2-15}]$$

- Where: D_p = Dose due to all real pathways to organ, o, of an individual in age group, a, from iodine-131, iodine-133, tritium, and radionuclides in particulate form with half-lives greater than eight days from all release sources (mRem).
- W' = Dispersion parameter for estimating the dose to an individual at the location where the combination of existing pathways and receptor age groups indicates the maximum potential exposures. Locations of interest are listed in the results of the annual Land Use Census,
- W' = X/Q for the inhalation pathway in sec/m^3 . X/Q is the annual average relative concentration at the location of interest. Values for X/Q are listed in the results of the annual Land Use Census. If desired, the highest individual receptor X/Q or X/Q value may be used, or
- W' = D/Q for the food and ground plane pathways in m^2 . D/Q is the annual average deposition at the location of interest. Values for D/Q are listed in the results of the annual Land Use Census. If desired, the highest individual receptor D/Q or D/Q value may be used.
- NOTE: For tritium, the dispersion parameter, W' is taken as the annual average X/Q values from information listed and maintained current in the results of the annual Land Use Census for inhalation, food and ground plane pathways.
- $R^P_{i,a,o}$ = Dose factor for radionuclide i, pathway p, age group a and organ o, in mRem/yr per uCi/m^3 for the inhalation pathway and m^2 (mRem/yr) per uCi/sec for food and ground plane pathways, except for tritium which is in mRem/yr per uCi/m^3 for all pathways. The values for $R^P_{i,a,o}$ for each pathway, radionuclide, age group and organ are listed in Table 2.4.
- The methodologies used for determining values of $R^P_{i,a,o}$ for each pathway are given in Appendices B through F.
- Q'_i = Cumulative release of radionuclide, i, during the period of interest (uCi). Q'_i is based on the activities measured in each plant vent stack from the analyses of the particulate and iodine samples required by Radiological Effluent Control 3/4.11.2.1, Table 4.11-2.
- I&PT = Iodines, particulates with half-lives greater than eight days, and tritium. These are the isotopes over which the summation function is to be performed.
- PATHS = The real pathways of exposure to individuals at the locations of interest.

2.4 DOSE PROJECTIONS FOR GASEOUS EFFLUENTS

Radiological Effluent Control 3/4.11.2.4 requires that appropriate portions of the PRIMARY PLANT VENTILATION SYSTEM and WASTE GAS HOLDUP SYSTEM be used to reduce releases of radioactivity when the projected doses due to the gaseous effluent from a unit to areas at or beyond the SITE BOUNDARY would exceed, in a 31-day period, either:

0.2 mrad to air from gamma radiation; or

0.4 mrad to air from beta radiation; or

0.3 mrem to any organ of a MEMBER OF THE PUBLIC.

The following calculational method is provided for performing this dose projection:

At least once every 31 days the gamma air dose, beta air dose and the maximum organ dose for each unit for the previous three months will be divided by the number of days in the three month period and multiplied by 31. Also, this dose projection may include the estimated dose due to any anticipated unusual releases during the period for which the projection is made, such as Waste Gas Decay Tank release. If the projected doses for a unit exceed any of the values listed above, appropriate portions of the PRIMARY PLANT VENTILATION SYSTEM and WASTE GAS HOLDUP SYSTEM shall be used to reduce radioactivity levels prior to release.

2.5 DOSE CALCULATIONS TO SUPPORT OTHER REQUIREMENTS

For the purpose of implementing the requirements of Radiological Effluent Control 6.9.1.4, the Annual Radioactive Effluent Release Report shall include an assessment of the radiation doses due to radioactive liquid and gaseous effluents from the station during the previous year of operation. This assessment shall be a summary of the doses determined in accordance with Section 1.3 for doses due to liquid effluents, Section 2.3.1 for air doses due to noble gases, and Section 2.3.2 for doses due to iodines, tritium, and particulates. This same report shall also include an assessment of the radiation doses from radioactive liquid and gaseous effluents to members of the public due to their activities inside the SITE BOUNDARY. This assessment shall be performed in accordance with the methodologies in Section 1.3, 2.3.1, and 2.3.2, using either historical average or concurrent dispersion and deposition parameters for the locations of interest, and taking into account occupancy factors. All assumptions and factors used in the determination shall be included in the report.

For the purpose of implementing Radiological Effluent Control 3/4.12.2 dose calculations for the new locations identified in the land use census shall be performed using the methodology in Section 2.3.2, substituting the appropriate pathway receptor dose factors and dispersion parameters for the location(s) of interest. Annual average dispersion parameters may be used for these calculations. If the land use census changes, the critical location (i.e., the location where an individual would be exposed to the highest dose) must be reevaluated for the nearest residence, the nearest milk animal, and the nearest vegetable garden. Additionally, when a location is identified that yields a calculated dose 20% greater than at a location where environmental samples are currently being obtained, add the new location within 30 days to the Radiological Environmental Monitoring locations described in Section 3.1 of this manual.

For the purpose of implementing Radiological Effluent Control 3/4.11.4, the total annual dose to any member of the public due to releases of radioactivity and to radiation from uranium fuel cycle sources may be determined by summing the annual doses determined for a member of the public in accordance with the methodology of Sections 1.3, 2.3.1, and 2.3.2 and the direct radiation dose contributions from the units and from outside storage tanks to the particular member of the public. This assessment must be performed in the event calculated doses from the effluent releases exceed twice the limits of Controls 3/4.11.1.2, 3/4.11.2.2, or 3/4.11.2.3. This assessment will be included in the Annual Radioactive Effluent Release Report to be submitted the year after the assessment was required. Otherwise, no assessments are required.

For the evaluation of doses to real individuals from liquid releases, the same calculation methods as employed in Section 1.3 will be used. However, more encompassing and realistic assumptions will be made concerning the dilution and ingestion of radionuclides. The results of the Radiological Environmental Monitoring Program will be used in determining the realistic dose based on actual measured radionuclide concentrations. For the evaluation of doses to real individuals from gaseous releases, the same calculational methods as employed in Sections 2.3.1 and 2.3.2 will be used. In Sections 2.3.1, the total body dose factor should be substituted for the gamma air dose factor (M_i) to determine the total body dose. Otherwise, the same calculational sequence applies. More realistic assumptions will be made concerning the actual location of real individuals, the meteorological conditions, and the consumption of food. Data obtained from the latest land use census should be used to determine locations for evaluating doses. The results of the Radiological Environmental Monitoring Program will be included in determining more realistic doses based on actual measured radionuclide concentrations.

The dose component due to direct radiation may be determined by calculation or actual measurement (e.g., thermoluminescent dosimeters, micro-R meter). The calculation or actual measurement of direct radiation shall be documented in the Special Report that must be submitted if this determination is required.

2.6 METEOROLOGICAL MODEL

2.6.1 Dispersion Calculations

Atmospheric dispersion for gaseous releases is calculated using a straight line flow Gaussian model similar to the Constant Mean Wind Direction model given in Regulatory Guide 1.111, Section C.1.c. The method given here is modified by including factors to account for plume depletion and effects of the open terrain. The average relative concentration is given by the following equation:

$$\frac{X}{Q} = 2.032 \delta K \sum_{j,k} \left(\frac{n_{jk}}{N r \bar{u}_{jk} \sum j(r)} \right) \quad [\text{Eq. 2-16}]$$

Where: X/Q = Average concentration normalized by source strength. (sec/m³)

$$2.032 = (2/\pi)^{1/2} \cdot (2\pi/16)^{-1}.$$

- δ = Plume depletion factor at distance r for the applicable stability class (Figure 2.2). Normally, a value of 1.0 is assumed when undepleted X/Q values are to be used in dose calculations.
- K = Terrain correction factor (Figure 2.5).
- n_{jk} = Number of hours meteorological conditions are observed to be in a given wind direction, wind speed class, k , and atmospheric stability class, j .
- N = Total hours of valid meteorological data throughout the period of release.

NOTE: If hourly meteorological data are used, all variable subscripts are dropped, n_{jk} and N are set equal to 1, and the hourly averaged meteorological variables are used in the model.

- r = Downwind distance from the release point to the location of interest. (meters)
- \bar{u}_{jk} = Average windspeed (midpoint of windspeed class, k) measured at the 10 meter level during stability class j . (meters/sec)
- $\Sigma_j(r)$ = Vertical plume spread with a volumetric correction for a release within the building wake cavity, at a distance, r , for stability class, j , expressed in meters.

NOTE: All parameters are considered dimensionless unless otherwise indicated.

The equation for calculating $\Sigma_j(r)$ is:

$$\Sigma_j(r) = \text{the lesser of } \begin{cases} (\sigma_j^2 + 0.5 b^2/\pi)^{1/2} & \text{[Eq. 2-17]} \\ \sqrt{3}\sigma_j & \text{[Eq. 2-18]} \end{cases}$$

- Where: σ_j = Vertical standard deviation of materials in the plume at distance, r , for atmospheric stability class, j , expressed in meters (Figure 2.3).
- 0.5 = Building shape factor.
- b = Vertical height of the reactor containment structure (79.4 meters).

2.6.2 Deposition Calculations

The relative deposition per unit area is calculated as follows:

$$\frac{D}{Q} = \frac{K D_g z}{0.3927 r} \quad [\text{Eq. 2-19}]$$

Where: D/Q = Deposition per unit area normalized by source strength (m^{-2})

D_g = Relative deposition rate for a ground level release (m^{-1})
(Figure 2.4)

z = Fraction of time the wind blows to the sector of interest.

NOTE: If hourly meteorological data are used, z is set equal to one.

0.3927 = Width in radians of a 22.5° sector.

Other variables are as previously defined.

NOTE: All parameters are considered dimensionless unless otherwise indicated.

2.7 DEFINITIONS OF GASEOUS EFFLUENTS PARAMETERS

<u>TERM</u>	<u>DEFINITION</u>
AF	Allocation Factor of 0.5 applied to account for releases from both stacks simultaneously. This factor will limit the release rate contribution from each stack to 1/2 the limit for the site.
B	vertical height of the reactor containment structure.
C_G	the alarm setpoint for each plant vent stack noble gas activity monitor. ($\mu\text{Ci}/\text{cm}^3$)
C_f	the alarm setpoint for each plant vent stack effluent release rate monitor. ($\mu\text{Ci}/\text{sec}$)
c_{aux}	the Auxiliary Building Ventilation Exhaust monitor alarm setpoint. ($\mu\text{Ci}/\text{cm}^3$)
c_{cont}	the Containment Atmosphere Gaseous monitor alarm setpoint. ($\mu\text{Ci}/\text{cm}^3$)
D_g	relative deposition rate for a ground-level release. (m^{-1})
D_o	the total organ dose rate due to tritium, iodines, and particulates with half-lives greater than eight days from all gaseous release sources. (mRem/yr)
D_{ov}	the organ dose rate due to tritium, iodines, and particulates with half-lives greater than eight days from gaseous release source v. (mRem/yr)

<u>TERM</u>	<u>DEFINITION</u>
D_p	dose to any organ of an individual from radioiodines, tritium and radionuclides in particulate form with half-lives greater than eight days from all release sources. (mRem)
D_s	Skin dose rate at the SITE BOUNDARY due to noble gases from all release sources. (mRem/yr)
D_{sv}	Skin dose rate at the SITE BOUNDARY due to noble gases from release source v. (mRem/yr)
D_t	Total body dose rate at the SITE BOUNDARY due to noble gases from all release sources. (mRem/yr)
D_{tv}	Total body dose rate at the SITE BOUNDARY due to noble gases from release source v. (mRem/yr)
D_β	Air dose due to beta emissions from noble gases from all release sources. (mRad)
D_γ	Air dose due to gamma emissions from noble gases from all release sources. (mRad)
D/Q	Annual average relative deposition at the location of interest. (m^{-2})
δ	Plume depletion factor at distance r for the appropriate stability class (radioiodines and particulates).
F_v	Flow rate from each release source v. (cm^3/sec)
F_{aux}	Maximum Auxiliary Building Ventilation flow rate (cm^3/sec) corresponding to 106,400 cfm.
F_{cont}	Maximum containment release flow rate (cm^3/sec) corresponding to 750 cfm for containment vents and 30,000 cfm for containment purges.
F_{PVS}	Maximum stack flow rate (cc/sec) corresponding to 115,000 cfm during normal operations and 130,000 cfm during containment purges.
K	terrain correction factor. (unitless)
K_i	total body dose factor due to gamma emissions from noble gas radionuclide i. (mRem/yr per uCi/m^3)
L_i	skin dose factor due to beta emissions from noble gas radionuclide i. (mRem/yr per uCi/m^3)
M_i	air dose factor due to gamma emissions from noble gas radionuclide i. (mrad/yr per uCi/m^3)
N_i	air dose factor due to beta emissions from noble gas radionuclide i. (mrad/yr per uCi/m^3)
n_{jk}	number of hours meteorological conditions are observed to be in a given wind direction, wind speed class k, and atmospheric stability class j.
N	total hours of valid meteorological data.
P_i	pathway dose rate parameter for radionuclide i, (other than noble gases) for the inhalation pathway. (mRem/yr per uCi/cm^3)

<u>TERM</u>	<u>DEFINITION</u>
Q_{aux}	the limiting release rate contribution from the Auxiliary Building Vent during WGDT releases. (uCi/sec)
Q_{cont}	the limiting release rate contribution from a containment release. (uCi/sec)
Q_i	total release rate of radionuclide i from all release sources. (uCi/sec)
Q_{iv}	Total release rate of radionuclide i from release source v. (uCi/sec)
Q'_i	Cumulative release of radionuclide i during the period of interest from all release sources. (uCi)
Q_{NG}	Actual release rate of noble gases from all release sources as calculated from the radionuclide concentrations determined from analyses of samples taken in accordance with Control 3/4.11.2.1, Table 4.11-2.
Q_{SITE}	Total site noble gas release rate limit corresponding to a dose rate at or beyond the SITE BOUNDARY of 500 mRem/yr to the total body or 3000 mRem/yr to the skin. (uCi/sec)
$R^p_{i,a,o}$	Dose factor for radionuclide i, pathway p, and age group a, and organ o (mRem/yr per uCi/m ³) or(m ² -mRem/yr per uCi/sec).
r	Distance from the point of release to the location of interest for dispersion calculations. (meters)
SF	Safety Factor of 0.5 applied to compensate for statistical fluctuations, errors of measurement, and non-uniform distribution of release activity between the stacks.
$\Sigma_j(r)$	Vertical plume spread with a volumetric correction for a release within the building wake cavity, at a distance, r, for stability class, j, expressed in meters.
σ_j	Vertical standard deviation of the plume concentration (in meters), at distance, r, for stability category j.
\bar{u}_{jk}	Wind speed (midpoint of windspeed class k) at ground level (m/sec) during atmosphere stability class j.
W'	Dispersion parameter for estimating the dose to an individual at the location where the combination of existing pathways and receptor age groups indicates the maximum exposures.
X/Q	Annual average relative concentration at the location of interest. (sec/m ³)
\bar{X}/Q	Highest annual average relative concentration at the SITE BOUNDARY. (sec/m ³) (3.3 x 10 ⁻⁶ sec/m ³ in the NNW sector)
X_{iv}	Measured concentration of radionuclide i present in each release source v. (uCi/cm ³).
z	Fraction of time the wind blows to the sector of interest.
1.1	Conversion factor of mRem skin dose per mRad air dose.
500	Dose rate limit to the total body of an individual at or beyond the SITE BOUNDARY due to noble gases from all release sources. (mRem/yr)

TERM

DEFINITION

3000

Dose rate limit to the skin of the body of the individual at or beyond the SITE BOUNDARY due to noble gases from all release sources.
(mRem/yr)

TABLE 2.1
SUMMARY OF GASEOUS RELEASE PATHWAYS

1. RELEASES VIA THE PLANT VENT STACKS

<u>RELEASE SOURCE</u>	<u>RELEASE TYPE</u>	<u>MAX. FLOW RATE (cfm)</u>	<u>MONITOR(S)</u>
Stack A	Continuous	115,000	XRE-5570A/XRE-5567A
Stack B	Continuous	115,000	XRE-5570B/XRE-5567B
WGDT's	Batch	20	XRE-5570A&B/XRE-5701
U-1 Cont. Vent.	Batch	750	1RE-5503
U-1 Cont. Purge	Batch	30,000	1RE-5503
U-2 Cont. Vent.	Batch	750	2RE-5503
U-2 Cont. Purge	Batch	30,000	2RE-5503

2. RELEASES VIA THE ILRT VENT

<u>RELEASE SOURCE</u>	<u>RELEASE TYPE</u>	<u>MAX. FLOW RATE (cfm)</u>	<u>MONITOR(S)</u>
ILRT	Batch	-	-

3) RELEASES FROM OUTSIDE BUILDINGS

<u>RELEASE SOURCE</u>	<u>RELEASE TYPE</u>	<u>MAX. FLOW RATE (cfm)</u>	<u>MONITOR(S)</u>
Outside Buildings	Continuous or Batch	-	-

TABLE 2.2
DOSE FACTORS FOR EXPOSURE TO A SEMI-INFINITE CLOUD OF NOBLE GASES*

Isotope	γ -Body***(K)	β -Skin***(L)	γ -Air**(M)	β -Air**(N)
Kr-83m	7.56E-02	---	1.93E+01	2.88E+02
Kr-85m	1.17E+03	1.46E+03	1.23E+03	1.97E+03
Kr-85	1.61E+01	1.34E+03	1.72E+01	1.95E+03
Kr-87	5.92E+03	9.73E+03	6.17E+03	1.03E+04
Kr-88	1.47E+04	2.37E+03	1.52E+04	2.93E+03
Kr-89	1.66E+04	1.01E+04	1.73E+04	1.06E+04
Kr- 90	1.56E+04	7.29E+03	1.63E+04	7.83E+03
Xe-131m	9.15E+01	4.76E+02	1.56E+02	1.11E+03
Xe-133m	2.51E+02	9.94E+02	3.27E+02	1.48E+03
Xe-133	2.94E+02	3.06E+02	3.53E+02	1.05E+03
Xe-135m	3.12E+03	7.11E+02	3.36E+03	7.39E+02
Xe-135	1.81E+03	1.86E+03	1.92E+03	2.46E+03
Xe-137	1.42E+03	1.22E+04	1.51E+03	1.27E+04
Xe-138	8.83E+03	4.13E+03	9.21E+03	4.75E+03
Ar-41	8.84E+03	2.69E+03	9.30E+03	3.28E+03

*Values taken from Reference 2, Table B-1

** $\frac{\text{mrad} - \text{m}^3}{\mu\text{Ci} - \text{yr}}$

*** $\frac{\text{mrem} - \text{m}^3}{\mu\text{Ci} - \text{yr}}$

TABLE 2.3
PATHWAY DOSE RATE PARAMETER (P_i)*

*BASED ON THE INHALATION PATHWAY
FOR THE CHILD AGE GROUP

NUCLIDE	ORGAN DOSE FACTORS						
	BONE	LIVER	T. BODY	THYROID	KIDNEY	LUNG	GI-LLI
H-3	0.00E+00	1.12E+03	1.12E+03	1.12E+03	1.12E+03	1.12E+03	1.12E+03
P-32	2.60E+06	1.14E+05	9.88E+04	0.00E+00	0.00E+00	0.00E+00	4.22E+04
CR-51	0.00E+00	0.00E+00	1.54E+02	8.55E+01	2.43E+01	1.70E+04	1.08E+03
MN-54	0.00E+00	4.29E+04	9.51E+03	0.00E+00	1.00E+04	1.58E+06	2.29E+04
FE-55	4.74E+04	2.52E+04	7.77E+03	0.00E+00	0.00E+00	1.11E+05	2.87E+03
FE-59	2.07E+04	3.34E+04	1.67E+04	0.00E+00	0.00E+00	1.27E+06	7.07E+04
CO-58	0.00E+00	1.77E+03	3.16E+03	0.00E+00	0.00E+00	1.11E+06	3.44E+04
CO-60	0.00E+00	1.31E+04	2.26E+04	0.00E+00	0.00E+00	7.07E+06	9.62E+04
NI-63	8.21E+05	4.63E+04	2.80E+04	0.00E+00	0.00E+00	2.75E+05	6.33E+03
ZN-65	4.26E+04	1.13E+05	7.03E+04	0.00E+00	7.14E+04	9.95E+05	1.63E+04
RB-86	0.00E+00	1.98E+05	1.14E+05	0.00E+00	0.00E+00	0.00E+00	7.99E+03
SR-89	5.99E+05	0.00E+00	1.72E+04	0.00E+00	0.00E+00	2.16E+06	1.67E+05
SR-90	1.01E+08	0.00E+00	6.44E+06	0.00E+00	0.00E+00	1.48E+07	3.43E+05
Y-91	9.14E+05	0.00E+00	2.44E+04	0.00E+00	0.00E+00	2.63E+06	1.84E+05
ZR-95	1.90E+05	4.18E+04	3.70E+04	0.00E+00	5.96E+04	2.23E+06	6.11E+04
NB-95	2.35E+04	9.18E+03	6.55E+03	0.00E+00	8.62E+03	6.14E+05	3.70E+04
RU-103	2.79E+03	0.00E+00	1.07E+03	0.00E+00	7.03E+03	6.62E+05	4.48E+04
RU-106	1.36E+05	0.00E+00	1.69E+04	0.00E+00	1.84E+05	1.43E+07	4.29E+05
AG-110M	1.69E+04	1.14E+04	9.14E+03	0.00E+00	2.12E+04	5.48E+06	1.00E+05
TE-125M	6.73E+03	2.33E+03	9.14E+02	1.92E+03	0.00E+00	4.77E+05	3.38E+04
TE-127M	2.49E+04	8.55E+03	3.02E+03	6.07E+03	6.36E+04	1.48E+06	7.14E+04
TE-129M	1.92E+04	6.85E+03	3.04E+03	6.33E+03	5.03E+04	1.76E+06	1.82E+05
I-131	4.81E+04	4.81E+04	2.73E+04	1.62E+07	7.88E+04	0.00E+00	2.84E+03
I-133	1.66E+04	2.03E+04	7.70E+03	3.85E+06	3.38E+04	0.00E+00	5.48E+03
CS-134	6.51E+05	1.01E+06	2.25E+05	0.00E+00	3.30E+05	1.21E+05	3.85E+03
CS-136	6.51E+04	1.71E+05	1.16E+05	0.00E+00	9.55E+04	1.45E+04	4.18E+03
CS-137	9.07E+05	8.25E+05	1.28E+05	0.00E+00	2.82E+05	1.04E+05	3.62E+03
BA-140	7.40E+04	6.48E+01	4.33E+03	0.00E+00	2.11E+01	1.74E+06	1.02E+05
CE-141	3.92E+04	1.95E+04	2.90E+03	0.00E+00	8.55E+03	5.44E+05	5.66E+04
CE-144	6.77E+06	2.12E+06	3.61E+05	0.00E+00	1.17E+06	1.20E+07	3.89E+05
PR-143	1.85E+04	5.55E+03	9.14E+02	0.00E+00	3.00E+03	4.33E+05	9.73E+04
ND-147	1.08E+04	8.73E+03	6.81E+02	0.00E+00	4.81E+03	3.28E+05	8.21E+04

TABLE 2.4
PATHWAY DOSE FACTORS

AGE GROUP: ALL	PATHWAY: GROUND PLANE	
NUCLIDE	ORGAN DOSE FACTORS	
	T. BODY	SKIN
H-3	0.00E+00	0.00E+00
P-32	0.00E+00	0.00E+00
CR-51	4.65E+06	5.50E+06
MN-54	1.39E+09	1.62E+09
FE-55	0.00E+00	0.00E+00
FE-59	2.73E+08	3.21E+08
CO-58	3.79E+08	4.44E+08
CO-60	2.15E+10	2.53E+10
NI-63	0.00E+00	0.00E+00
ZN-65	7.47E+08	8.59E+08
RB-86	8.97E+06	1.03E+07
SR-89	2.16E+04	2.51E+04
SR-90	0.00E+00	0.00E+00
Y-91	1.07E+06	1.21E+06
ZR-95	2.45E+08	2.84E+08
NB-95	1.37E+08	1.61E+08
RU-103	1.08E+08	1.26E+08
RU-106	4.22E+08	5.06E+08
AG-110M	3.44E+09	4.01E+09
TE-125M	1.55E+06	2.13E+06
TE-127M	9.17E+04	1.08E+05
TE-129M	1.98E+07	2.31E+07
I-131	1.72E+07	2.09E+07
I-133	2.45E+06	2.98E+06
CS-134	6.86E+09	8.00E+09
CS-136	1.51E+08	1.71E+08
CS-137	1.03E+10	1.20E+10
BA-140	2.06E+07	2.36E+07
CE-141	1.37E+07	1.54E+07
CE-144	6.96E+07	8.05E+07
PR-143	0.00E+00	0.00E+00
ND-147	8.39E+06	1.01E+07

TABLE 2.4
PATHWAY DOSE FACTORS

AGE GROUP: ADULT		PATHWAY: GRASS - COW - MILK					
NUCLIDE	ORGAN DOSE FACTORS						
	BONE	LIVER	T. BODY	THYROID	KIDNEY	LUNG	GI-LLI
H-3	0.00E+00	7.62E+02	7.62E+02	7.62E+02	7.62E+02	7.62E+02	7.62E+02
P-32	1.70E+10	1.06E+09	6.58E+08	0.00E+00	0.00E+00	0.00E+00	1.91E+09
CR-51	0.00E+00	0.00E+00	2.85E+04	1.70E+04	6.28E+03	3.78E+04	7.17E+06
MN-54	0.00E+00	8.40E+06	1.60E+06	0.00E+00	2.50E+06	0.00E+00	2.57E+07
FE-55	2.51E+07	1.73E+07	4.04E+06	0.00E+00	0.00E+00	9.66E+06	9.93E+06
FE-59	2.97E+07	6.97E+07	2.67E+07	0.00E+00	0.00E+00	1.95E+07	2.32E+08
CO-58	0.00E+00	4.71E+06	1.05E+07	0.00E+00	0.00E+00	0.00E+00	9.54E+07
CO-60	0.00E+00	1.64E+07	3.61E+07	0.00E+00	0.00E+00	0.00E+00	3.08E+08
NI-63	6.72E+09	4.65E+08	2.25E+08	0.00E+00	0.00E+00	0.00E+00	9.71E+07
ZN-65	1.37E+09	4.36E+09	1.97E+09	0.00E+00	2.91E+09	0.00E+00	2.74E+09
RB-86	0.00E+00	2.59E+09	1.21E+09	0.00E+00	0.00E+00	0.00E+00	5.10E+08
SR-89	1.45E+09	0.00E+00	4.16E+07	0.00E+00	0.00E+00	0.00E+00	2.32E+08
SR-90	4.67E+10	0.00E+00	1.15E+10	0.00E+00	0.00E+00	0.00E+00	1.35E+09
Y-91	8.57E+03	0.00E+00	2.29E+02	0.00E+00	0.00E+00	0.00E+00	4.72E+06
ZR-95	9.41E+02	3.02E+02	2.04E+02	0.00E+00	4.74E+02	0.00E+00	9.57E+05
NB-95	8.24E+04	4.58E+04	2.46E+04	0.00E+00	4.53E+04	0.00E+00	2.78E+08
RU-103	1.02E+03	0.00E+00	4.38E+02	0.00E+00	3.88E+03	0.00E+00	1.19E+05
RU-106	2.04E+04	0.00E+00	2.58E+03	0.00E+00	3.93E+04	0.00E+00	1.32E+06
AG-110M	5.81E+07	5.38E+07	3.19E+07	0.00E+00	1.06E+08	0.00E+00	2.19E+10
TE-125M	1.63E+07	5.89E+06	2.18E+06	4.89E+06	6.61E+07	0.00E+00	6.49E+07
TE-127M	4.57E+07	1.63E+07	5.57E+06	1.17E+07	1.86E+08	0.00E+00	1.53E+08
TE-129M	6.01E+07	2.24E+07	9.51E+06	2.06E+07	2.51E+08	0.00E+00	3.02E+08
I-131	2.96E+08	4.23E+08	2.42E+08	1.39E+11	7.25E+08	0.00E+00	1.12E+08
I-133	3.87E+06	6.73E+06	2.05E+06	9.88E+08	1.17E+07	0.00E+00	6.04E+06
CS-134	5.64E+09	1.34E+10	1.10E+10	0.00E+00	4.34E+09	1.44E+09	2.35E+08
CS-136	2.63E+08	1.04E+09	7.48E+08	0.00E+00	5.78E+08	7.92E+07	1.18E+08
CS-137	7.37E+09	1.01E+10	6.60E+09	0.00E+00	3.42E+09	1.14E+09	1.95E+08
BA-140	2.69E+07	3.38E+04	1.76E+06	0.00E+00	1.15E+04	1.94E+04	5.54E+07
CE-141	4.84E+03	3.27E+03	3.71E+02	0.00E+00	1.52E+03	0.00E+00	1.25E+07
CE-144	3.57E+05	1.49E+05	1.92E+04	0.00E+00	8.85E+04	0.00E+00	1.21E+08
PR-143	1.57E+02	6.32E+01	7.81E+00	0.00E+00	3.65E+01	0.00E+00	6.90E+05
ND-147	9.40E+01	1.09E+02	6.50E+00	0.00E+00	6.35E+01	0.00E+00	5.22E+05

TABLE 2.4
PATHWAY DOSE FACTORS

NUCLIDE	ORGAN DOSE FACTORS						
	BONE	LIVER	T. BODY	THYROID	KIDNEY	LUNG	GI-LLI
H-3	0.00E+00	9.93E+02	9.93E+02	9.93E+02	9.93E+02	9.93E+02	9.93E+02
P-32	3.15E+10	1.95E+09	1.22E+09	0.00E+00	0.00E+00	0.00E+00	2.65E+09
CR-51	0.00E+00	0.00E+00	4.99E+04	2.77E+04	1.09E+04	7.13E+04	8.39E+06
MN-54	0.00E+00	1.40E+07	2.78E+06	0.00E+00	4.19E+06	0.00E+00	2.88E+07
FE-55	4.46E+07	3.16E+07	7.37E+06	0.00E+00	0.00E+00	2.01E+07	1.37E+07
FE-59	5.19E+07	1.21E+08	4.68E+07	0.00E+00	0.00E+00	3.82E+07	2.86E+08
CO-58	0.00E+00	7.94E+06	1.83E+07	0.00E+00	0.00E+00	0.00E+00	1.10E+08
CO-60	0.00E+00	2.78E+07	6.27E+07	0.00E+00	0.00E+00	0.00E+00	3.62E+08
NI-63	1.18E+10	8.36E+08	4.01E+08	0.00E+00	0.00E+00	0.00E+00	1.33E+08
ZN-65	2.11E+09	7.32E+09	3.42E+09	0.00E+00	4.69E+09	0.00E+00	3.10E+09
RB-86	0.00E+00	4.73E+09	2.22E+09	0.00E+00	0.00E+00	0.00E+00	7.00E+08
SR-89	2.68E+09	0.00E+00	7.67E+07	0.00E+00	0.00E+00	0.00E+00	3.19E+08
SR-90	6.62E+10	0.00E+00	1.63E+10	0.00E+00	0.00E+00	0.00E+00	1.86E+09
Y-91	1.58E+04	0.00E+00	4.24E+02	0.00E+00	0.00E+00	0.00E+00	6.48E+06
ZR-95	1.65E+03	5.21E+02	3.58E+02	0.00E+00	7.65E+02	0.00E+00	1.20E+06
NB-95	1.41E+05	7.82E+04	4.30E+04	0.00E+00	7.58E+04	0.00E+00	3.34E+08
RU-103	1.81E+03	0.00E+00	7.75E+02	0.00E+00	6.39E+03	0.00E+00	1.51E+05
RU-106	3.76E+04	0.00E+00	4.73E+03	0.00E+00	7.24E+04	0.00E+00	1.80E+06
AG-110M	9.64E+07	9.12E+07	5.55E+07	0.00E+00	1.74E+08	0.00E+00	2.56E+10
TE-125M	3.01E+07	1.08E+07	4.02E+06	8.40E+06	0.00E+00	0.00E+00	8.87E+07
TE-127M	8.45E+07	3.00E+07	1.00E+07	2.01E+07	3.42E+08	0.00E+00	2.11E+08
TE-129M	1.10E+08	4.09E+07	1.74E+07	3.56E+07	4.61E+08	0.00E+00	4.14E+08
I-131	5.38E+08	7.53E+08	4.05E+08	2.20E+11	1.30E+09	0.00E+00	1.49E+08
I-133	7.08E+06	1.20E+07	3.66E+06	1.68E+09	2.11E+07	0.00E+00	9.09E+06
CS-134	9.83E+09	2.31E+10	1.07E+10	0.00E+00	7.35E+09	2.81E+09	2.88E+08
CS-136	4.49E+08	1.77E+09	1.19E+09	0.00E+00	9.63E+08	1.52E+08	1.42E+08
CS-137	1.34E+10	1.78E+10	6.21E+09	0.00E+00	6.06E+09	2.36E+09	2.54E+08
BA-140	4.87E+07	5.97E+04	3.14E+06	0.00E+00	2.02E+04	4.01E+04	7.51E+07
CE-141	8.89E+03	5.94E+03	6.82E+02	0.00E+00	2.80E+03	0.00E+00	1.70E+07
CE-144	6.59E+05	2.73E+05	3.54E+04	0.00E+00	1.63E+05	0.00E+00	1.66E+08
PR-143	2.90E+02	1.16E+02	1.44E+01	0.00E+00	6.73E+01	0.00E+00	9.55E+05
ND-147	1.81E+02	1.97E+02	1.18E+01	0.00E+00	1.16E+02	0.00E+00	7.12E+05

TABLE 2.4
PATHWAY DOSE FACTORS

NUCLIDE	ORGAN DOSE FACTORS						
	BONE	LIVER	T. BODY	THYROID	KIDNEY	LUNG	GI-LLI
H-3	0.00E+00	1.57E+03	1.57E+03	1.57E+03	1.57E+03	1.57E+03	1.57E+03
P-32	7.77E+10	3.64E+09	3.00E+09	0.00E+00	0.00E+00	0.00E+00	2.15E+09
CR-51	0.00E+00	0.00E+00	1.02E+05	5.65E+04	1.54E+04	1.03E+05	5.40E+06
MN-54	0.00E+00	2.10E+07	5.59E+06	0.00E+00	5.89E+06	0.00E+00	1.76E+07
FE-55	1.12E+08	5.94E+07	1.84E+07	0.00E+00	0.00E+00	3.36E+07	1.10E+07
FE-59	1.20E+08	1.95E+08	9.70E+07	0.00E+00	0.00E+00	5.65E+07	2.03E+08
CO-58	0.00E+00	1.21E+07	3.72E+07	0.00E+00	0.00E+00	0.00E+00	7.08E+07
CO-60	0.00E+00	4.32E+07	1.27E+08	0.00E+00	0.00E+00	0.00E+00	2.39E+08
NI-63	2.97E+10	1.59E+09	1.01E+09	0.00E+00	0.00E+00	0.00E+00	1.07E+08
ZN-65	4.14E+09	1.10E+10	6.86E+09	0.00E+00	6.95E+09	0.00E+00	1.94E+09
RB-86	0.00E+00	8.78E+09	5.40E+09	0.00E+00	0.00E+00	0.00E+00	5.65E+08
SR-89	6.63E+09	0.00E+00	1.89E+08	0.00E+00	0.00E+00	0.00E+00	2.57E+08
SR-90	1.12E+11	0.00E+00	2.84E+10	0.00E+00	0.00E+00	0.00E+00	1.51E+09
Y-91	3.91E+04	0.00E+00	1.05E+03	0.00E+00	0.00E+00	0.00E+00	5.21E+06
ZR-95	3.84E+03	8.43E+02	7.51E+02	0.00E+00	1.21E+03	0.00E+00	8.80E+05
NB-95	3.18E+05	1.24E+05	8.86E+04	0.00E+00	1.16E+05	0.00E+00	2.29E+08
RU-103	4.29E+03	0.00E+00	1.65E+03	0.00E+00	1.08E+04	0.00E+00	1.11E+05
RU-106	9.25E+04	0.00E+00	1.15E+04	0.00E+00	1.25E+05	0.00E+00	1.44E+06
AG-110M	2.09E+08	1.41E+08	1.13E+08	0.00E+00	2.63E+08	0.00E+00	1.68E+10
TE-125M	7.39E+07	2.00E+07	9.85E+06	2.07E+07	0.00E+00	0.00E+00	7.13E+07
TE-127M	2.08E+08	5.61E+07	2.47E+07	4.98E+07	5.94E+08	0.00E+00	1.69E+08
TE-129M	2.72E+08	7.59E+07	4.22E+07	8.76E+07	7.98E+08	0.00E+00	3.31E+08
I-131	1.31E+09	1.31E+09	7.46E+08	4.34E+11	2.16E+09	0.00E+00	1.17E+08
I-133	1.72E+07	2.13E+07	8.05E+06	3.95E+09	3.55E+07	0.00E+00	8.58E+06
CS-134	2.27E+10	3.72E+10	7.85E+09	0.00E+00	1.15E+10	4.14E+09	2.01E+08
CS-136	1.01E+09	2.79E+09	1.80E+09	0.00E+00	1.49E+09	2.21E+08	9.80E+07
CS-137	3.23E+10	3.09E+10	4.56E+09	0.00E+00	1.01E+10	3.62E+09	1.93E+08
BA-140	1.18E+08	1.03E+05	6.86E+06	0.00E+00	3.35E+04	6.14E+04	5.96E+07
CE-141	2.19E+04	1.09E+04	1.62E+03	0.00E+00	4.79E+03	0.00E+00	1.36E+07
CE-144	1.63E+06	5.09E+05	8.67E+04	0.00E+00	2.82E+05	0.00E+00	1.33E+08
PR-143	7.18E+02	2.16E+02	3.56E+01	0.00E+00	1.17E+02	0.00E+00	7.75E+05
ND-147	4.45E+02	3.61E+02	2.79E+01	0.00E+00	1.98E+02	0.00E+00	5.71E+05

TABLE 2.4
PATHWAY DOSE FACTORS

NUCLIDE	ORGAN DOSE FACTORS						
	BONE	LIVER	T. BODY	THYROID	KIDNEY	LUNG	GI-LLI
H-3	0.00E+00	2.38E+03	2.38E+03	2.38E+03	2.38E+03	2.38E+03	2.38E+03
P-32	1.60E+11	9.42E+09	6.21E+09	0.00E+00	0.00E+00	0.00E+00	2.17E+09
CR-51	0.00E+00	0.00E+00	1.61E+05	1.05E+05	2.30E+04	2.05E+05	4.70E+06
MN-54	0.00E+00	3.91E+07	8.85E+06	0.00E+00	8.65E+06	0.00E+00	1.43E+07
FE-55	1.35E+08	8.74E+07	2.34E+07	0.00E+00	0.00E+00	4.27E+07	1.11E+07
FE-59	2.25E+08	3.93E+08	1.55E+08	0.00E+00	0.00E+00	1.16E+08	1.88E+08
CO-58	0.00E+00	2.43E+07	6.06E+07	0.00E+00	0.00E+00	0.00E+00	6.05E+07
CO-60	0.00E+00	8.83E+07	2.08E+08	0.00E+00	0.00E+00	0.00E+00	2.10E+08
NI-63	3.50E+10	2.16E+09	1.21E+09	0.00E+00	0.00E+00	0.00E+00	1.08E+08
ZN-65	5.56E+09	1.91E+10	8.79E+09	0.00E+00	9.24E+09	0.00E+00	1.61E+10
RB-86	0.00E+00	2.23E+10	1.10E+10	0.00E+00	0.00E+00	0.00E+00	5.70E+08
SR-89	1.26E+10	0.00E+00	3.62E+08	0.00E+00	0.00E+00	0.00E+00	2.59E+08
SR-90	1.22E+11	0.00E+00	3.10E+10	0.00E+00	0.00E+00	0.00E+00	1.52E+09
Y-91	7.34E+04	0.00E+00	1.95E+03	0.00E+00	0.00E+00	0.00E+00	5.26E+06
ZR-95	6.81E+03	1.66E+03	1.18E+03	0.00E+00	1.79E+03	0.00E+00	8.27E+05
NB-95	5.94E+05	2.45E+05	1.41E+05	0.00E+00	1.75E+05	0.00E+00	2.07E+08
RU-103	8.68E+03	0.00E+00	2.90E+03	0.00E+00	1.81E+04	0.00E+00	1.06E+05
RU-106	1.91E+05	0.00E+00	2.38E+04	0.00E+00	2.25E+05	0.00E+00	1.45E+06
AG-110M	3.86E+08	2.82E+08	1.87E+08	0.00E+00	4.03E+08	0.00E+00	1.46E+10
TE-125M	1.51E+08	5.05E+07	2.04E+07	5.08E+07	0.00E+00	0.00E+00	7.19E+07
TE-127M	4.22E+08	1.40E+08	5.10E+07	1.22E+08	1.04E+09	0.00E+00	1.70E+08
TE-129M	5.58E+08	1.91E+08	8.59E+07	2.14E+08	1.39E+09	0.00E+00	3.33E+08
I-131	2.72E+09	3.21E+09	1.41E+09	1.05E+12	3.75E+09	0.00E+00	1.15E+08
I-133	3.63E+07	5.29E+07	1.55E+07	9.62E+09	6.22E+07	0.00E+00	8.96E+06
CS-134	3.65E+10	6.81E+10	6.88E+09	0.00E+00	1.75E+10	7.19E+09	1.85E+08
CS-136	1.98E+09	5.83E+09	2.18E+09	0.00E+00	2.32E+09	4.75E+08	8.85E+07
CS-137	5.15E+10	6.03E+10	4.27E+09	0.00E+00	1.62E+10	6.55E+09	1.89E+08
BA-140	2.42E+08	2.42E+05	1.25E+07	0.00E+00	5.75E+04	1.49E+05	5.94E+07
CE-141	4.34E+04	2.65E+04	3.12E+03	0.00E+00	8.17E+03	0.00E+00	1.37E+07
CE-144	2.33E+06	9.53E+05	1.30E+05	0.00E+00	3.85E+05	0.00E+00	1.34E+08
PR-143	1.49E+03	5.56E+02	7.37E+01	0.00E+00	2.07E+02	0.00E+00	7.84E+05
ND-147	8.83E+02	9.07E+02	5.55E+01	0.00E+00	3.50E+02	0.00E+00	5.75E+05

TABLE 2.4
PATHWAY DOSE FACTORS

NUCLIDE	ORGAN DOSE FACTORS						
	BONE	LIVER	T. BODY	THYROID	KIDNEY	LUNG	GI-LLI
H-3	0.00E+00	3.24E+02	3.24E+02	3.24E+02	3.24E+02	3.24E+02	3.24E+02
P-32	4.63E+09	2.88E+08	1.79E+08	0.00E+00	0.00E+00	0.00E+00	5.21E+08
CR-51	0.00E+00	0.00E+00	7.04E+03	4.21E+03	1.55E+03	9.35E+03	1.77E+06
MN-54	0.00E+00	9.18E+06	1.75E+06	0.00E+00	2.73E+06	0.00E+00	2.81E+07
FE-55	2.93E+08	2.03E+08	4.73E+07	0.00E+00	0.00E+00	1.13E+08	1.16E+08
FE-59	2.66E+08	6.25E+08	2.39E+08	0.00E+00	0.00E+00	1.75E+08	2.08E+09
CO-58	0.00E+00	1.82E+07	4.09E+07	0.00E+00	0.00E+00	0.00E+00	3.70E+08
CO-60	0.00E+00	7.52E+07	1.66E+08	0.00E+00	0.00E+00	0.00E+00	1.41E+09
NI-63	1.89E+10	1.31E+09	6.33E+08	0.00E+00	0.00E+00	0.00E+00	2.73E+08
ZN-65	3.56E+08	1.13E+09	5.12E+08	0.00E+00	7.57E+08	0.00E+00	7.13E+08
RB-86	0.00E+00	4.87E+08	2.27E+08	0.00E+00	0.00E+00	0.00E+00	9.59E+07
SR-89	3.02E+08	0.00E+00	8.66E+06	0.00E+00	0.00E+00	0.00E+00	4.84E+07
SR-90	1.24E+10	0.00E+00	3.05E+09	0.00E+00	0.00E+00	0.00E+00	3.60E+08
Y-91	1.13E+06	0.00E+00	3.03E+04	0.00E+00	0.00E+00	0.00E+00	6.24E+08
ZR-95	1.87E+06	6.01E+05	4.07E+05	0.00E+00	9.43E+05	0.00E+00	1.90E+09
NB-95	2.30E+06	1.28E+06	6.87E+05	0.00E+00	1.26E+06	0.00E+00	7.76E+09
RU-103	1.05E+08	0.00E+00	4.53E+07	0.00E+00	4.02E+08	0.00E+00	1.23E+10
RU-106	2.80E+09	0.00E+00	3.54E+08	0.00E+00	5.41E+09	0.00E+00	1.81E+11
AG-110M	6.68E+06	6.18E+06	3.67E+06	0.00E+00	1.22E+07	0.00E+00	2.52E+09
TE-125M	3.59E+08	1.30E+08	4.81E+07	1.08E+08	1.46E+09	0.00E+00	1.43E+09
TE-127M	1.12E+09	3.99E+08	1.36E+08	2.85E+08	4.53E+09	0.00E+00	3.74E+09
TE-129M	1.13E+09	4.23E+08	1.79E+08	3.89E+08	4.73E+09	0.00E+00	5.71E+09
I-131	1.08E+07	1.54E+07	8.82E+06	5.04E+09	2.64E+07	0.00E+00	4.06E+06
I-133	3.68E-01	6.41E-01	1.95E-01	9.42E+01	1.12E+00	0.00E+00	5.76E-01
CS-134	6.58E+08	1.57E+09	1.28E+09	0.00E+00	5.07E+08	1.68E+08	2.74E+07
CS-136	1.21E+07	4.78E+07	3.44E+07	0.00E+00	2.66E+07	3.65E+06	5.43E+06
CS-137	8.72E+08	1.19E+09	7.82E+08	0.00E+00	4.05E+08	1.35E+08	2.31E+07
BA-140	2.90E+07	3.64E+04	1.90E+06	0.00E+00	1.24E+04	2.08E+04	5.96E+07
CE-141	1.41E+04	9.51E+03	1.08E+03	0.00E+00	4.42E+03	0.00E+00	3.64E+07
CE-144	1.46E+06	6.10E+05	7.83E+04	0.00E+00	3.62E+05	0.00E+00	4.93E+08
PR-143	2.09E+04	8.40E+03	1.04E+03	0.00E+00	4.85E+03	0.00E+00	9.17E+07
ND-147	7.08E+03	8.18E+03	4.90E+02	0.00E+00	4.78E+03	0.00E+00	3.93E+07

TABLE 2.4
PATHWAY DOSE FACTORS

NUCLIDE	ORGAN DOSE FACTORS						
	BONE	LIVER	T. BODY	THYROID	KIDNEY	LUNG	GI-LLI
H-3	0.00E+00	1.93E+02	1.93E+02	1.93E+02	1.93E+02	1.93E+02	1.93E+02
P-32	3.91E+09	2.42E+08	1.52E+08	0.00E+00	0.00E+00	0.00E+00	3.29E+08
CR-51	0.00E+00	0.00E+00	5.63E+03	3.13E+03	1.23E+03	8.03E+03	9.46E+05
MN-54	0.00E+00	7.00E+06	1.39E+06	0.00E+00	2.09E+06	0.00E+00	1.44E+07
FE-55	2.38E+08	1.69E+08	3.94E+07	0.00E+00	0.00E+00	1.07E+08	7.31E+07
FE-59	2.12E+08	4.95E+08	1.91E+08	0.00E+00	0.00E+00	1.56E+08	1.17E+09
CO-58	0.00E+00	1.40E+07	3.24E+07	0.00E+00	0.00E+00	0.00E+00	1.94E+08
CO-60	0.00E+00	5.83E+07	1.31E+08	0.00E+00	0.00E+00	0.00E+00	7.60E+08
NI-63	1.52E+10	1.07E+09	5.15E+08	0.00E+00	0.00E+00	0.00E+00	1.71E+08
ZN-65	2.50E+08	8.68E+08	4.05E+08	0.00E+00	5.56E+08	0.00E+00	3.68E+08
RB-86	0.00E+00	4.06E+08	1.91E+08	0.00E+00	0.00E+00	0.00E+00	6.00E+07
SR-89	2.55E+08	0.00E+00	7.29E+06	0.00E+00	0.00E+00	0.00E+00	3.03E+07
SR-90	8.04E+09	0.00E+00	1.99E+09	0.00E+00	0.00E+00	0.00E+00	2.26E+08
Y-91	9.54E+05	0.00E+00	2.56E+04	0.00E+00	0.00E+00	0.00E+00	3.91E+08
ZR-95	1.50E+06	4.73E+05	3.25E+05	0.00E+00	6.95E+05	0.00E+00	1.09E+09
NB-95	1.79E+06	9.95E+05	5.48E+05	0.00E+00	9.64E+05	0.00E+00	4.25E+09
RU-103	8.56E+07	0.00E+00	3.66E+07	0.00E+00	3.02E+08	0.00E+00	7.15E+09
RU-106	2.36E+09	0.00E+00	2.97E+08	0.00E+00	4.54E+09	0.00E+00	1.13E+11
AG-110M	5.06E+06	4.78E+06	2.91E+06	0.00E+00	9.13E+06	0.00E+00	1.34E+09
TE-125M	3.03E+08	1.09E+08	4.05E+07	8.46E+07	0.00E+00	0.00E+00	8.94E+08
TE-127M	9.41E+08	3.34E+08	1.12E+08	2.24E+08	3.81E+09	0.00E+00	2.35E+09
TE-129M	9.49E+08	3.52E+08	1.50E+08	3.06E+08	3.97E+09	0.00E+00	3.56E+09
I-131	8.93E+06	1.25E+07	6.72E+06	3.65E+09	2.15E+07	0.00E+00	2.47E+06
I-133	3.08E-01	5.22E-01	1.59E-01	7.29E+01	9.16E-01	0.00E+00	3.95E-01
CS-134	5.23E+08	1.23E+09	5.71E+08	0.00E+00	3.91E+08	1.49E+08	1.53E+07
CS-136	9.43E+06	3.71E+07	2.49E+07	0.00E+00	2.02E+07	3.18E+06	2.99E+06
CS-137	7.24E+08	9.63E+08	3.35E+08	0.00E+00	3.28E+08	1.27E+08	1.37E+07
BA-140	2.39E+07	2.93E+04	1.54E+06	0.00E+00	9.94E+03	1.97E+04	3.69E+07
CE-141	1.18E+04	7.87E+03	9.05E+02	0.00E+00	3.71E+03	0.00E+00	2.25E+07
CE-144	1.23E+06	5.08E+05	6.60E+04	0.00E+00	3.03E+05	0.00E+00	3.09E+08
PR-143	1.76E+04	7.03E+03	8.76E+02	0.00E+00	4.08E+03	0.00E+00	5.79E+07
ND-147	6.23E+03	6.78E+03	4.06E+02	0.00E+00	3.98E+03	0.00E+00	2.44E+07

TABLE 2.4
PATHWAY DOSE FACTORS

NUCLIDE	ORGAN DOSE FACTORS						
	BONE	LIVER	T. BODY	THYROID	KIDNEY	LUNG	GI-LLI
H-3	0.00E+00	2.34E+02	2.34E+02	2.34E+02	2.34E+02	2.34E+02	2.34E+02
P-32	7.38E+09	3.45E+08	2.85E+08	0.00E+00	0.00E+00	0.00E+00	2.04E+08
CR-51	0.00E+00	0.00E+00	8.78E+03	4.88E+03	1.33E+03	8.90E+03	4.66E+05
MN-54	0.00E+00	8.01E+06	2.13E+06	0.00E+00	2.25E+06	0.00E+00	6.73E+06
FE-55	4.57E+08	2.43E+08	7.52E+07	0.00E+00	0.00E+00	1.37E+08	4.49E+07
FE-59	3.77E+08	6.10E+08	3.04E+08	0.00E+00	0.00E+00	1.77E+08	6.35E+08
CO-58	0.00E+00	1.64E+07	5.03E+07	0.00E+00	0.00E+00	0.00E+00	9.58E+07
CO-60	0.00E+00	6.93E+07	2.04E+08	0.00E+00	0.00E+00	0.00E+00	3.84E+08
NI-63	2.91E+10	1.56E+09	9.91E+08	0.00E+00	0.00E+00	0.00E+00	1.05E+08
ZN-65	3.76E+08	1.00E+09	6.22E+08	0.00E+00	6.31E+08	0.00E+00	1.76E+08
RB-86	0.00E+00	5.76E+08	3.54E+08	0.00E+00	0.00E+00	0.00E+00	3.71E+07
SR-89	4.82E+08	0.00E+00	1.38E+07	0.00E+00	0.00E+00	0.00E+00	1.87E+07
SR-90	1.04E+10	0.00E+00	2.64E+09	0.00E+00	0.00E+00	0.00E+00	1.40E+08
Y-91	1.80E+06	0.00E+00	4.82E+04	0.00E+00	0.00E+00	0.00E+00	2.40E+08
ZR-95	2.66E+06	5.86E+05	5.21E+05	0.00E+00	8.38E+05	0.00E+00	6.11E+08
NB-95	3.10E+06	1.12E+06	8.63E+05	0.00E+00	1.13E+06	0.00E+00	2.23E+09
RU-103	1.55E+08	0.00E+00	5.96E+07	0.00E+00	3.90E+08	0.00E+00	4.01E+09
RU-106	4.44E+09	0.00E+00	5.54E+08	0.00E+00	6.00E+09	0.00E+00	6.91E+10
AG-110M	8.39E+06	5.67E+06	4.53E+06	0.00E+00	1.06E+07	0.00E+00	6.74E+08
TE-125M	5.69E+08	1.54E+08	7.59E+07	1.60E+08	0.00E+00	0.00E+00	5.49E+08
TE-127M	1.78E+09	4.78E+08	2.11E+08	4.25E+08	5.06E+09	0.00E+00	1.44E+09
TE-129M	1.79E+09	5.00E+08	2.78E+08	5.77E+08	5.26E+09	0.00E+00	2.18E+09
I-131	1.66E+07	1.67E+07	9.48E+06	5.52E+09	2.74E+07	0.00E+00	1.48E+06
I-133	5.72E-01	7.08E-01	2.68E-01	1.31E+02	1.18E+00	0.00E+00	2.85E-01
CS-134	9.23E+08	1.51E+09	3.19E+08	0.00E+00	4.69E+08	1.68E+08	8.16E+06
CS-136	1.63E+07	4.48E+07	2.90E+07	0.00E+00	2.39E+07	3.56E+06	1.57E+06
CS-137	1.33E+09	1.28E+09	1.89E+08	0.00E+00	4.16E+08	1.50E+08	8.00E+06
BA-140	4.42E+07	3.87E+04	2.58E+06	0.00E+00	1.26E+04	2.31E+04	2.24E+07
CE-141	2.22E+04	1.11E+04	1.65E+03	0.00E+00	4.86E+03	0.00E+00	1.38E+07
CE-144	2.32E+06	7.26E+05	1.24E+05	0.00E+00	4.02E+05	0.00E+00	1.89E+08
PR-143	3.33E+04	1.00E+04	1.65E+03	0.00E+00	5.42E+03	0.00E+00	3.60E+07
ND-147	1.17E+04	9.48E+03	7.34E+02	0.00E+00	5.20E+03	0.00E+00	1.50E+07

TABLE 2.4
PATHWAY DOSE FACTORS

AGE GROUP: INFANT		PATHWAY: GRASS - COW - MEAT					
NUCLIDE	ORGAN DOSE FACTORS						
	BONE	LIVER	T. BODY	THYROID	KIDNEY	LUNG	GI-LLI
H-3	0.00E+00	0.00E+00	0.00E+00	0.00E+00	0.00E+00	0.00E+00	0.00E+00
P-32	0.00E+00	0.00E+00	0.00E+00	0.00E+00	0.00E+00	0.00E+00	0.00E+00
CR-51	0.00E+00	0.00E+00	0.00E+00	0.00E+00	0.00E+00	0.00E+00	0.00E+00
MN-54	0.00E+00	0.00E+00	0.00E+00	0.00E+00	0.00E+00	0.00E+00	0.00E+00
FE-55	0.00E+00	0.00E+00	0.00E+00	0.00E+00	0.00E+00	0.00E+00	0.00E+00
FE-59	0.00E+00	0.00E+00	0.00E+00	0.00E+00	0.00E+00	0.00E+00	0.00E+00
CO-58	0.00E+00	0.00E+00	0.00E+00	0.00E+00	0.00E+00	0.00E+00	0.00E+00
CO-60	0.00E+00	0.00E+00	0.00E+00	0.00E+00	0.00E+00	0.00E+00	0.00E+00
NI-63	0.00E+00	0.00E+00	0.00E+00	0.00E+00	0.00E+00	0.00E+00	0.00E+00
ZN-65	0.00E+00	0.00E+00	0.00E+00	0.00E+00	0.00E+00	0.00E+00	0.00E+00
RB-86	0.00E+00	0.00E+00	0.00E+00	0.00E+00	0.00E+00	0.00E+00	0.00E+00
SR-89	0.00E+00	0.00E+00	0.00E+00	0.00E+00	0.00E+00	0.00E+00	0.00E+00
SR-90	0.00E+00	0.00E+00	0.00E+00	0.00E+00	0.00E+00	0.00E+00	0.00E+00
Y-91	0.00E+00	0.00E+00	0.00E+00	0.00E+00	0.00E+00	0.00E+00	0.00E+00
ZR-95	0.00E+00	0.00E+00	0.00E+00	0.00E+00	0.00E+00	0.00E+00	0.00E+00
NB-95	0.00E+00	0.00E+00	0.00E+00	0.00E+00	0.00E+00	0.00E+00	0.00E+00
RU-103	0.00E+00	0.00E+00	0.00E+00	0.00E+00	0.00E+00	0.00E+00	0.00E+00
RU-106	0.00E+00	0.00E+00	0.00E+00	0.00E+00	0.00E+00	0.00E+00	0.00E+00
AG-110M	0.00E+00	0.00E+00	0.00E+00	0.00E+00	0.00E+00	0.00E+00	0.00E+00
TE-125M	0.00E+00	0.00E+00	0.00E+00	0.00E+00	0.00E+00	0.00E+00	0.00E+00
TE-127M	0.00E+00	0.00E+00	0.00E+00	0.00E+00	0.00E+00	0.00E+00	0.00E+00
TE-129M	0.00E+00	0.00E+00	0.00E+00	0.00E+00	0.00E+00	0.00E+00	0.00E+00
I-131	0.00E+00	0.00E+00	0.00E+00	0.00E+00	0.00E+00	0.00E+00	0.00E+00
I-133	0.00E+00	0.00E+00	0.00E+00	0.00E+00	0.00E+00	0.00E+00	0.00E+00
CS-134	0.00E+00	0.00E+00	0.00E+00	0.00E+00	0.00E+00	0.00E+00	0.00E+00
CS-136	0.00E+00	0.00E+00	0.00E+00	0.00E+00	0.00E+00	0.00E+00	0.00E+00
CS-137	0.00E+00	0.00E+00	0.00E+00	0.00E+00	0.00E+00	0.00E+00	0.00E+00
BA-140	0.00E+00	0.00E+00	0.00E+00	0.00E+00	0.00E+00	0.00E+00	0.00E+00
CE-141	0.00E+00	0.00E+00	0.00E+00	0.00E+00	0.00E+00	0.00E+00	0.00E+00
CE-144	0.00E+00	0.00E+00	0.00E+00	0.00E+00	0.00E+00	0.00E+00	0.00E+00
PR-143	0.00E+00	0.00E+00	0.00E+00	0.00E+00	0.00E+00	0.00E+00	0.00E+00
ND-147	0.00E+00	0.00E+00	0.00E+00	0.00E+00	0.00E+00	0.00E+00	0.00E+00

TABLE 2.4
PATHWAY DOSE FACTORS

AGE GROUP: ADULT		PATHWAY: GRASS - GOAT - MILK					
NUCLIDE	ORGAN DOSE FACTORS						
	BONE	LIVER	T. BODY	THYROID	KIDNEY	LUNG	GI-LLI
H-3	0.00E+00	1.56E+03	1.56E+03	1.56E+03	1.56E+03	1.56E+03	1.56E+03
P-32	2.05E+10	1.27E+09	7.92E+08	0.00E+00	0.00E+00	0.00E+00	2.30E+09
CR-51	0.00E+00	0.00E+00	3.43E+03	2.05E+03	7.56E+02	4.55E+03	8.63E+05
MN-54	0.00E+00	1.01E+06	1.93E+05	0.00E+00	3.01E+05	0.00E+00	3.10E+06
FE-55	3.27E+05	2.26E+05	5.26E+04	0.00E+00	0.00E+00	1.26E+05	1.30E+05
FE-59	3.87E+05	9.09E+05	3.48E+05	0.00E+00	0.00E+00	2.54E+05	3.03E+06
CO-58	0.00E+00	5.66E+05	1.27E+06	0.00E+00	0.00E+00	0.00E+00	1.15E+07
CO-60	0.00E+00	1.97E+06	4.35E+06	0.00E+00	0.00E+00	0.00E+00	3.70E+07
NI-63	8.08E+08	5.60E+07	2.71E+07	0.00E+00	0.00E+00	0.00E+00	1.17E+07
ZN-65	1.65E+08	5.24E+08	2.37E+08	0.00E+00	3.51E+08	0.00E+00	3.30E+08
RB-86	0.00E+00	3.12E+08	1.45E+08	0.00E+00	0.00E+00	0.00E+00	6.14E+07
SR-89	3.05E+09	0.00E+00	8.76E+07	0.00E+00	0.00E+00	0.00E+00	4.89E+08
SR-90	9.84E+10	0.00E+00	2.41E+10	0.00E+00	0.00E+00	0.00E+00	2.84E+09
Y-91	1.03E+03	0.00E+00	2.76E+01	0.00E+00	0.00E+00	0.00E+00	5.68E+05
ZR-95	1.13E+02	3.63E+01	2.46E+01	0.00E+00	5.70E+01	0.00E+00	1.15E+05
NB-95	9.92E+03	5.52E+03	2.97E+03	0.00E+00	5.45E+03	0.00E+00	3.35E+07
RU-103	1.22E+02	0.00E+00	5.27E+01	0.00E+00	4.67E+02	0.00E+00	1.43E+04
RU-106	2.45E+03	0.00E+00	3.10E+02	0.00E+00	4.73E+03	0.00E+00	1.59E+05
AG-110M	6.99E+06	6.47E+06	3.84E+06	0.00E+00	1.27E+07	0.00E+00	2.64E+09
TE-125M	1.96E+06	7.09E+05	2.62E+05	5.89E+05	7.96E+06	0.00E+00	7.81E+06
TE-127M	5.50E+06	1.97E+06	6.70E+05	1.41E+06	2.23E+07	0.00E+00	1.84E+07
TE-129M	7.23E+06	2.70E+06	1.14E+06	2.48E+06	3.02E+07	0.00E+00	3.64E+07
I-131	3.56E+08	5.09E+08	2.92E+08	1.67E+11	8.73E+08	0.00E+00	1.34E+08
I-133	4.65E+06	8.10E+06	2.47E+06	1.19E+09	1.41E+07	0.00E+00	7.28E+06
CS-134	1.70E+10	4.04E+10	3.30E+10	0.00E+00	1.31E+10	4.34E+09	7.07E+08
CS-136	7.92E+08	3.13E+09	2.25E+09	0.00E+00	1.74E+09	2.38E+08	3.55E+08
CS-137	2.22E+10	3.03E+10	1.99E+10	0.00E+00	1.03E+10	3.42E+09	5.87E+08
BA-140	3.24E+06	4.07E+03	2.12E+05	0.00E+00	1.38E+03	2.33E+03	6.67E+06
CE-141	5.82E+02	3.94E+02	4.47E+01	0.00E+00	1.83E+02	0.00E+00	1.51E+06
CE-144	4.30E+04	1.80E+04	2.31E+03	0.00E+00	1.07E+04	0.00E+00	1.45E+07
PR-143	1.90E+01	7.60E+00	9.40E-01	0.00E+00	4.39E+00	0.00E+00	8.30E+04
ND-147	1.13E+01	1.31E+01	7.82E-01	0.00E+00	7.65E+00	0.00E+00	6.28E+04

TABLE 2.4
PATHWAY DOSE FACTORS

AGE GROUP: TEEN		PATHWAY: GRASS - GOAT - MILK					
NUCLIDE	ORGAN DOSE FACTORS						
	BONE	LIVER	T. BODY	THYROID	KIDNEY	LUNG	GI-LLI
H-3	0.00E+00	2.04E+03	2.04E+03	2.04E+03	2.04E+03	2.04E+03	2.04E+03
P-32	3.78E+10	2.34E+09	1.46E+09	0.00E+00	0.00E+00	0.00E+00	3.18E+09
CR-51	0.00E+00	0.00E+00	5.99E+03	3.33E+03	1.31E+03	8.55E+03	1.01E+06
MN-54	0.00E+00	1.68E+06	3.34E+05	0.00E+00	5.02E+05	0.00E+00	3.45E+06
FE-55	5.79E+05	4.11E+05	9.58E+04	0.00E+00	0.00E+00	2.61E+05	1.78E+05
FE-59	6.74E+05	1.57E+06	6.08E+05	0.00E+00	0.00E+00	4.96E+05	3.72E+06
CO-58	0.00E+00	9.53E+05	2.20E+06	0.00E+00	0.00E+00	0.00E+00	1.31E+07
CO-60	0.00E+00	3.34E+06	7.52E+06	0.00E+00	0.00E+00	0.00E+00	4.35E+07
NI-63	1.42E+09	1.00E+08	4.81E+07	0.00E+00	0.00E+00	0.00E+00	1.60E+07
ZN-65	2.53E+08	8.78E+08	4.10E+08	0.00E+00	5.62E+08	0.00E+00	3.72E+08
RB-86	0.00E+00	5.67E+08	2.67E+08	0.00E+00	0.00E+00	0.00E+00	8.40E+07
SR-89	5.62E+09	0.00E+00	1.61E+08	0.00E+00	0.00E+00	0.00E+00	6.69E+08
SR-90	1.39E+11	0.00E+00	3.43E+10	0.00E+00	0.00E+00	0.00E+00	3.90E+09
Y-91	1.90E+03	0.00E+00	5.09E+01	0.00E+00	0.00E+00	0.00E+00	7.78E+05
ZR-95	1.98E+02	6.25E+01	4.30E+01	0.00E+00	9.18E+01	0.00E+00	1.44E+05
NB-95	1.69E+04	9.38E+03	5.16E+03	0.00E+00	9.09E+03	0.00E+00	4.01E+07
RU-103	2.17E+02	0.00E+00	9.29E+01	0.00E+00	7.66E+02	0.00E+00	1.82E+04
RU-106	4.50E+03	0.00E+00	5.68E+02	0.00E+00	8.69E+03	0.00E+00	2.16E+05
AG-110M	1.16E+07	1.09E+07	6.65E+06	0.00E+00	2.09E+07	0.00E+00	3.07E+09
TE-125M	3.61E+06	1.30E+06	4.82E+05	1.01E+06	0.00E+00	0.00E+00	1.06E+07
TE-127M	1.01E+07	3.59E+06	1.20E+06	2.41E+06	4.11E+07	0.00E+00	2.52E+07
TE-129M	1.32E+07	4.90E+06	2.09E+06	4.26E+06	5.53E+07	0.00E+00	4.96E+07
I-131	6.45E+08	9.03E+08	4.85E+08	2.64E+11	1.56E+09	0.00E+00	1.79E+08
I-133	8.49E+06	1.44E+07	4.40E+06	2.01E+09	2.53E+07	0.00E+00	1.09E+07
CS-134	2.95E+10	6.93E+10	3.22E+10	0.00E+00	2.20E+10	8.41E+09	8.62E+08
CS-136	1.35E+09	5.30E+09	3.56E+09	0.00E+00	2.89E+09	4.55E+08	4.27E+08
CS-137	4.02E+10	5.34E+10	1.86E+10	0.00E+00	1.82E+10	7.07E+09	7.60E+08
BA-140	5.84E+06	7.16E+03	3.76E+05	0.00E+00	2.43E+03	4.81E+03	9.01E+06
CE-141	1.07E+03	7.12E+02	8.18E+01	0.00E+00	3.35E+02	0.00E+00	2.04E+06
CE-144	7.90E+04	3.27E+04	4.25E+03	0.00E+00	1.95E+04	0.00E+00	1.99E+07
PR-143	3.48E+01	1.39E+01	1.73E+00	0.00E+00	8.08E+00	0.00E+00	1.15E+05
ND-147	2.18E+01	2.37E+01	1.42E+00	0.00E+00	1.39E+01	0.00E+00	8.54E+04

TABLE 2.4
PATHWAY DOSE FACTORS

AGE GROUP: CHILD		PATHWAY: GRASS - GOAT - MILK					
NUCLIDE	ORGAN DOSE FACTORS						
	BONE	LIVER	T. BODY	THYROID	KIDNEY	LUNG	GI-LLI
H-3	0.00E+00	3.20E+03	3.20E+03	3.20E+03	3.20E+03	3.20E+03	3.20E+03
P-32	9.32E+10	4.36E+09	3.59E+09	0.00E+00	0.00E+00	0.00E+00	2.58E+09
CR-51	0.00E+00	0.00E+00	1.22E+04	6.78E+03	1.85E+03	1.24E+04	6.48E+05
MN-54	0.00E+00	2.52E+00	6.71E+05	0.00E+00	7.06E+05	0.00E+00	2.11E+06
FE-55	1.45E+06	7.71E+00	2.39E+05	0.00E+00	0.00E+00	4.36E+05	1.43E+05
FE-59	1.56E+06	2.53E+06	1.26E+06	0.00E+00	0.00E+00	7.34E+05	2.64E+06
CO-58	0.00E+00	1.46E+06	4.46E+06	0.00E+00	0.00E+00	0.00E+00	8.49E+06
CO-60	0.00E+00	5.18E+06	1.53E+07	0.00E+00	0.00E+00	0.00E+00	2.87E+07
NI-63	3.56E+09	1.91E+08	1.21E+08	0.00E+00	0.00E+00	0.00E+00	1.28E+07
ZN-65	4.96E+08	1.32E+09	8.22E+08	0.00E+00	8.33E+08	0.00E+00	2.32E+08
RB-86	0.00E+00	1.05E+09	6.47E+08	0.00E+00	0.00E+00	0.00E+00	6.77E+07
SR-89	1.39E+10	0.00E+00	3.97E+08	0.00E+00	0.00E+00	0.00E+00	5.39E+08
SR-90	2.35E+11	0.00E+00	5.95E+10	0.00E+00	0.00E+00	0.00E+00	3.16E+09
Y-91	4.69E+03	0.00E+00	1.25E+02	0.00E+00	0.00E+00	0.00E+00	6.24E+05
ZR-95	4.60E+02	1.01E+02	9.00E+01	0.00E+00	1.45E+02	0.00E+00	1.05E+05
NB-95	3.82E+04	1.49E+04	1.06E+04	0.00E+00	1.40E+04	0.00E+00	2.75E+07
RU-103	5.14E+02	0.00E+00	1.98E+02	0.00E+00	1.29E+03	0.00E+00	1.33E+04
RU-106	1.11E+04	0.00E+00	1.38E+03	0.00E+00	1.50E+04	0.00E+00	1.73E+05
AG-110M	2.51E+07	1.69E+07	1/35E+07	0.00E+00	3.15E+07	0.00E+00	2.01E+09
TE-125M	8.86E+06	2.40E+06	1.18E+06	2.49E+06	0.00E+00	0.00E+00	8.55E+06
TE-127M	2.50E+07	6.72E+06	2.96E+06	5.97E+06	7.12E+07	0.00E+00	2.02E+07
TE-129M	3.26E+07	9.10E+06	5.06E+06	1.05E+07	9.56E+07	0.00E+00	3.97E+07
I-131	1.57E+09	1.57E+09	8.95E+08	5.21E+11	2.58E+09	0.00E+00	1.40E+08
I-133	2.06E+07	2.55E+07	9.66E+06	4.74E+09	4.25E+07	0.00E+00	1.03E+07
CS-134	6.80E+10	1.12E+11	2.35E+10	0.00E+00	3.46E+10	1.24E+10	6.01E+08
CS-136	3.04E+09	8.36E+09	5.41E+09	0.00E+00	4.45E+09	6.64E+08	2.94E+08
CS-137	9.68E+10	9.26E+10	1.37E+10	0.00E+00	3.02E+10	1.09E+10	5.80E+08
BA-140	1.41E+07	1.24E+04	8.23E+05	0.00E+00	4.02E+03	7.37E+03	7.15E+06
CE-141	2.63E+03	1.31E+03	1.95E+02	0.00E+00	5.74E+02	0.00E+00	1.63E+06
CE-144	1.95E+05	6.11E+04	1.04E+04	0.00E+00	3.38E+04	0.00E+00	1.59E+07
PR-143	8.61E+01	2.59E+01	4.27E+00	0.00E+00	1.40E+01	0.00E+00	9.29E+04
ND-147	5.34E+01	4.33E+01	3.35E+00	0.00E+00	2.37E+01	0.00E+00	6.85E+04

TABLE 2.4
PATHWAY DOSE FACTORS

AGE GROUP: INFANT		PATHWAY: GRASS - GOAT - MILK					
NUCLIDE	ORGAN DOSE FACTORS						
	BONE	LIVER	T. BODY	THYROID	KIDNEY	LUNG	GI-LLI
H-3	0.00E+00	4.86E+03	4.86E+03	4.86E+03	4.86E+03	4.86E+03	4.86E+03
P-32	1.92E+11	1.13E+10	7.44E+09	0.00E+00	0.00E+00	0.00E+00	2.60E+09
CR-51	0.00E+00	0.00E+00	1.94E+04	1.26E+04	2.76E+03	2.46E+04	5.64E+05
MN-54	0.00E+00	4.68E+06	1.06E+06	0.00E+00	1.04E+06	0.00E+00	1.72E+06
FE-55	1.76E+06	1.14E+06	3.03E+05	0.00E+00	0.00E+00	5.55E+05	1.44E+05
FE-59	2.92E+06	5.10E+06	2.01E+06	0.00E+00	0.00E+00	1.51E+06	2.44E+06
CO-58	0.00E+00	2.91E+06	7.26E+06	0.00E+00	0.00E+00	0.00E+00	7.25E+06
CO-60	0.00E+00	1.06E+07	2.50E+07	0.00E+00	0.00E+00	0.00E+00	2.52E+07
NI-63	4.19E+09	2.59E+08	1.46E+08	0.00E+00	0.00E+00	0.00E+00	1.29E+07
ZN-65	6.67E+08	2.29E+09	1.05E+09	0.00E+00	1.11E+09	0.00E+00	1.93E+09
RB-86	0.00E+00	2.67E+09	1.32E+09	0.00E+00	0.00E+00	0.00E+00	6.83E+07
SR-89	2.65E+10	0.00E+00	7.59E+08	0.00E+00	0.00E+00	0.00E+00	5.44E+08
SR-90	2.55E+11	0.00E+00	6.50E+10	0.00E+00	0.00E+00	0.00E+00	3.19E+09
Y-91	8.80E+03	0.00E+00	2.34E+02	0.00E+00	0.00E+00	0.00E+00	6.31E+05
ZR-95	8.17E+02	1.99E+02	1.41E+02	0.00E+00	2.15E+02	0.00E+00	9.91E+04
NB-95	7.13E+04	2.93E+04	1.70E+04	0.00E+00	2.10E+04	0.00E+00	2.48E+07
RU-103	1.04E+03	0.00E+00	3.48E+02	0.00E+00	2.17E+03	0.00E+00	1.27E+04
RU-106	2.28E+04	0.00E+00	2.85E+03	0.00E+00	2.70E+04	0.00E+00	1.73E+05
AG-110M	4.63E+07	3.38E+07	2.24E+07	0.00E+00	4.84E+07	0.00E+00	1.75E+09
TE-125M	1.81E+07	6.05E+06	2.45E+06	6.09E+06	0.00E+00	0.00E+00	8.62E+06
TE-127M	5.06E+07	1.68E+07	6.12E+06	1.46E+07	1.24E+08	0.00E+00	2.04E+07
TE-129M	6.69E+07	2.29E+07	1.03E+07	2.57E+07	1.67E+08	0.00E+00	3.99E+07
I-131	3.27E+09	3.85E+09	1.69E+09	1.27E+12	4.50E+09	0.00E+00	1.37E+08
I-133	4.36E+07	6.35E+07	1.86E+07	1.15E+10	7.46E+07	0.00E+00	1.07E+07
CS-134	1.09E+11	2.04E+11	2.06E+10	0.00E+00	5.26E+10	2.15E+10	5.55E+08
CS-136	5.94E+09	1.75E+10	6.52E+09	0.00E+00	6.96E+09	1.42E+09	2.65E+08
CS-137	1.54E+11	1.81E+11	1.28E+10	0.00E+00	4.85E+10	1.96E+10	5.65E+08
BA-140	2.90E+07	2.90E+04	1.50E+06	0.00E+00	6.89E+03	1.78E+04	7.13E+06
CE-141	5.21E+03	3.18E+03	3.74E+02	0.00E+00	9.79E+02	0.00E+00	1.64E+06
CE-144	2.79E+05	1.14E+05	1.56E+04	0.00E+00	4.62E+04	0.00E+00	1.60E+07
PR-143	1.78E+02	6.66E+01	8.83E+00	0.00E+00	2.48E+01	0.00E+00	9.40E+04
ND-147	1.06E+02	1.09E+02	6.66E+00	0.00E+00	4.19E+01	0.00E+00	6.89E+04

TABLE 2.4
PATHWAY DOSE FACTORS

NUCLIDE	ORGAN DOSE FACTORS						
	BONE	LIVER	T. BODY	THYROID	KIDNEY	LUNG	GI-LLI
H-3	0.00E+00	2.26E+03	2.26E+03	2.26E+03	2.26E+03	2.26E+03	2.26E+03
P-32	1.40E+09	8.69E+07	5.40E+07	0.00E+00	0.00E+00	0.00E+00	1.57E+08
CR-51	0.00E+00	0.00E+00	4.64E+04	2.77E+04	1.02E+04	6.15E+04	1.17E+07
MN-54	0.00E+00	3.13E+08	5.97E+07	0.00E+00	9.31E+07	0.00E+00	9.58E+08
FE-55	2.10E+08	1.45E+08	3.38E+07	0.00E+00	0.00E+00	8.08E+07	8.31E+07
FE-59	1.26E+08	2.97E+08	1.14E+08	0.00E+00	0.00E+00	8.29E+07	9.89E+08
CO-58	0.00E+00	3.07E+07	6.89E+07	0.00E+00	0.00E+00	0.00E+00	6.23E+08
CO-60	0.00E+00	1.67E+08	3.69E+08	0.00E+00	0.00E+00	0.00E+00	3.14E+09
NI-63	1.04E+10	7.21E+08	3.49E+08	0.00E+00	0.00E+00	0.00E+00	1.50E+08
ZN-65	3.17E+08	1.01E+09	4.56E+08	0.00E+00	6.75E+08	0.00E+00	6.36E+08
RB-86	0.00E+00	2.19E+08	1.02E+08	0.00E+00	0.00E+00	0.00E+00	4.32E+07
SR-89	9.98E+09	0.00E+00	2.86E+08	0.00E+00	0.00E+00	0.00E+00	1.60E+09
SR-90	6.05E+11	0.00E+00	1.48E+11	0.00E+00	0.00E+00	0.00E+00	1.75E+10
Y-91	5.12E+06	0.00E+00	1.37E+05	0.00E+00	0.00E+00	0.00E+00	2.82E+09
ZR-95	1.17E+06	3.77E+05	2.55E+05	0.00E+00	5.91E+05	0.00E+00	1.19E+09
NB-95	1.42E+05	7.92E+04	4.26E+04	0.00E+00	7.83E+04	0.00E+00	4.81E+08
RU-103	4.77E+06	0.00E+00	2.06E+06	0.00E+00	1.82E+07	0.00E+00	5.57E+08
RU-106	1.93E+08	0.00E+00	2.44E+07	0.00E+00	3.72E+08	0.00E+00	1.25E+10
AG-110M	1.05E+07	9.75E+06	5.79E+06	0.00E+00	1.92E+07	0.00E+00	3.98E+09
TE-125M	9.66E+07	3.50E+07	1.29E+07	2.90E+07	3.93E+08	0.00E+00	3.86E+08
TE-127M	3.49E+08	1.25E+08	4.26E+07	8.93E+07	1.42E+09	0.00E+00	1.17E+09
TE-129M	2.51E+08	9.37E+07	3.97E+07	8.63E+07	1.05E+09	0.00E+00	1.26E+09
I-131	8.08E+07	1.16E+08	6.62E+07	3.79E+10	1.98E+08	0.00E+00	3.05E+07
I-133	2.09E+06	3.63E+06	1.11E+06	5.34E+08	6.33E+06	0.00E+00	3.26E+06
CS-134	4.67E+09	1.11E+10	9.08E+09	0.00E+00	3.59E+09	1.19E+09	1.94E+08
CS-136	4.28E+07	1.69E+08	1.22E+08	0.00E+00	9.41E+07	1.29E+07	1.92E+07
CS-137	6.36E+09	8.70E+09	5.70E+09	0.00E+00	2.95E+09	9.81E+08	1.68E+08
BA-140	1.29E+08	1.62E+05	8.47E+06	0.00E+00	5.52E+04	9.29E+04	2.66E+08
CE-141	1.97E+05	1.33E+05	1.51E+04	0.00E+00	6.20E+04	0.00E+00	5.10E+08
CE-144	3.29E+07	1.38E+07	1.77E+06	0.00E+00	8.16E+06	0.00E+00	1.11E+10
PR-143	6.25E+04	2.51E+04	3.10E+03	0.00E+00	1.45E+04	0.00E+00	2.74E+08
ND-147	3.34E+04	3.85E+04	2.31E+03	0.00E+00	2.25E+04	0.00E+00	1.85E+08

TABLE 2.4
PATHWAY DOSE FACTORS

NUCLIDE	AGE GROUP: TEEN							PATHWAY: VEGETATION						
	ORGAN DOSE FACTORS													
	BONE	LIVER	T. BODY	THYROID	KIDNEY	LUNG	GI-LLI	BONE	LIVER	T. BODY	THYROID	KIDNEY	LUNG	GI-LLI
H-3	0.00E+00	2.59E+03	2.59E+03	2.59E+03	2.59E+03	2.59E+03	2.59E+03	0.00E+00	2.59E+03	2.59E+03	2.59E+03	2.59E+03	2.59E+03	2.59E+03
P-32	1.60E+09	9.91E+07	6.20E+07	0.00E+00	0.00E+00	0.00E+00	1.34E+08	1.60E+09	9.91E+07	6.20E+07	0.00E+00	0.00E+00	0.00E+00	1.34E+08
CR-51	0.00E+00	0.00E+00	6.16E+04	3.42E+04	1.35E+04	8.79E+04	1.03E+07	0.00E+00	0.00E+00	6.16E+04	3.42E+04	1.35E+04	8.79E+04	1.03E+07
MN-54	0.00E+00	4.54E+08	9.01E+07	0.00E+00	1.36E+08	0.00E+00	9.32E+08	0.00E+00	4.54E+08	9.01E+07	0.00E+00	1.36E+08	0.00E+00	9.32E+08
FE-55	3.26E+08	2.31E+08	5.39E+07	0.00E+00	0.00E+00	1.47E+08	1.00E+08	3.26E+08	2.31E+08	5.39E+07	0.00E+00	0.00E+00	1.47E+08	1.00E+08
FE-59	1.80E+08	4.19E+08	1.62E+08	0.00E+00	0.00E+00	1.32E+08	9.91E+08	1.80E+08	4.19E+08	1.62E+08	0.00E+00	0.00E+00	1.32E+08	9.91E+08
CO-58	0.00E+00	4.36E+07	1.01E+08	0.00E+00	0.00E+00	0.00E+00	6.01E+08	0.00E+00	4.36E+07	1.01E+08	0.00E+00	0.00E+00	0.00E+00	6.01E+08
CO-60	0.00E+00	2.49E+08	5.60E+08	0.00E+00	0.00E+00	0.00E+00	3.24E+09	0.00E+00	2.49E+08	5.60E+08	0.00E+00	0.00E+00	0.00E+00	3.24E+09
NI-63	1.61E+10	1.13E+09	5.45E+08	0.00E+00	0.00E+00	0.00E+00	1.81E+08	1.61E+10	1.13E+09	5.45E+08	0.00E+00	0.00E+00	0.00E+00	1.81E+08
ZN-65	4.24E+08	1.47E+09	6.86E+08	0.00E+00	9.42E+08	0.00E+00	6.23E+08	4.24E+08	1.47E+09	6.86E+08	0.00E+00	9.42E+08	0.00E+00	6.23E+08
RB-86	0.00E+00	2.73E+08	1.28E+08	0.00E+00	0.00E+00	0.00E+00	4.04E+07	0.00E+00	2.73E+08	1.28E+08	0.00E+00	0.00E+00	0.00E+00	4.04E+07
SR-89	1.52E+10	0.00E+00	4.34E+08	0.00E+00	0.00E+00	0.00E+00	1.80E+09	1.52E+10	0.00E+00	4.34E+08	0.00E+00	0.00E+00	0.00E+00	1.80E+09
SR-90	7.51E+11	0.00E+00	1.85E+11	0.00E+00	0.00E+00	0.00E+00	2.11E+10	7.51E+11	0.00E+00	1.85E+11	0.00E+00	0.00E+00	0.00E+00	2.11E+10
Y-91	7.84E+06	0.00E+00	2.10E+05	0.00E+00	0.00E+00	0.00E+00	3.22E+09	7.84E+06	0.00E+00	2.10E+05	0.00E+00	0.00E+00	0.00E+00	3.22E+09
ZR-95	1.72E+06	5.43E+05	3.73E+05	0.00E+00	7.98E+05	0.00E+00	1.25E+09	1.72E+06	5.43E+05	3.73E+05	0.00E+00	7.98E+05	0.00E+00	1.25E+09
NB-95	1.92E+05	1.07E+05	5.87E+04	0.00E+00	1.03E+05	0.00E+00	4.56E+08	1.92E+05	1.07E+05	5.87E+04	0.00E+00	1.03E+05	0.00E+00	4.56E+08
RU-103	6.82E+06	0.00E+00	2.92E+06	0.00E+00	2.41E+07	0.00E+00	5.70E+08	6.82E+06	0.00E+00	2.92E+06	0.00E+00	2.41E+07	0.00E+00	5.70E+08
RU-106	3.09E+08	0.00E+00	3.90E+07	0.00E+00	5.97E+08	0.00E+00	1.48E+10	3.09E+08	0.00E+00	3.90E+07	0.00E+00	5.97E+08	0.00E+00	1.48E+10
AG-110M	1.52E+07	1.43E+07	8.72E+06	0.00E+00	2.74E+07	0.00E+00	4.03E+09	1.52E+07	1.43E+07	8.72E+06	0.00E+00	2.74E+07	0.00E+00	4.03E+09
TE-125M	1.48E+08	5.34E+07	1.98E+07	4.14E+07	0.00E+00	0.00E+00	4.37E+08	1.48E+08	5.34E+07	1.98E+07	4.14E+07	0.00E+00	0.00E+00	4.37E+08
TE-127M	5.52E+08	1.96E+08	6.56E+07	1.31E+08	2.24E+09	0.00E+00	1.37E+09	5.52E+08	1.96E+08	6.56E+07	1.31E+08	2.24E+09	0.00E+00	1.37E+09
TE-129M	3.61E+08	1.34E+08	5.72E+07	1.17E+08	1.51E+09	0.00E+00	1.36E+09	3.61E+08	1.34E+08	5.72E+07	1.17E+08	1.51E+09	0.00E+00	1.36E+09
I-131	7.69E+07	1.08E+08	5.78E+07	3.14E+10	1.85E+08	0.00E+00	2.13E+07	7.69E+07	1.08E+08	5.78E+07	3.14E+10	1.85E+08	0.00E+00	2.13E+07
I-133	1.94E+06	3.29E+06	1.00E+06	4.59E+08	5.77E+06	0.00E+00	2.49E+06	1.94E+06	3.29E+06	1.00E+06	4.59E+08	5.77E+06	0.00E+00	2.49E+06
CS-134	7.10E+09	1.67E+10	7.75E+09	0.00E+00	5.31E+09	2.03E+09	2.08E+08	7.10E+09	1.67E+10	7.75E+09	0.00E+00	5.31E+09	2.03E+09	2.08E+08
CS-136	4.39E+07	1.73E+08	1.16E+08	0.00E+00	9.41E+07	1.48E+07	1.39E+07	4.39E+07	1.73E+08	1.16E+08	0.00E+00	9.41E+07	1.48E+07	1.39E+07
CS-137	1.01E+10	1.35E+10	4.69E+09	0.00E+00	4.59E+09	1.78E+09	1.92E+08	1.01E+10	1.35E+10	4.69E+09	0.00E+00	4.59E+09	1.78E+09	1.92E+08
BA-140	1.39E+08	1.71E+05	8.97E+06	0.00E+00	5.78E+04	1.15E+05	2.15E+08	1.39E+08	1.71E+05	8.97E+06	0.00E+00	5.78E+04	1.15E+05	2.15E+08
CE-141	2.83E+05	1.89E+05	2.17E+04	0.00E+00	8.90E+04	0.00E+00	5.41E+08	2.83E+05	1.89E+05	2.17E+04	0.00E+00	8.90E+04	0.00E+00	5.41E+08
CE-144	5.28E+07	2.18E+07	2.83E+06	0.00E+00	1.30E+07	0.00E+00	1.33E+10	5.28E+07	2.18E+07	2.83E+06	0.00E+00	1.30E+07	0.00E+00	1.33E+10
PR-143	6.99E+04	2.79E+04	3.48E+03	0.00E+00	1.62E+04	0.00E+00	2.30E+08	6.99E+04	2.79E+04	3.48E+03	0.00E+00	1.62E+04	0.00E+00	2.30E+08
ND-147	3.62E+04	3.94E+04	2.36E+03	0.00E+00	2.31E+04	0.00E+00	1.42E+08	3.62E+04	3.94E+04	2.36E+03	0.00E+00	2.31E+04	0.00E+00	1.42E+08

TABLE 2.4
PATHWAY DOSE FACTORS

NUCLIDE	AGE GROUP: CHILD							PATHWAY: VEGETATION						
	ORGAN DOSE FACTORS													
	BONE	LIVER	T. BODY	THYROID	KIDNEY	LUNG	GI-LLI	BONE	LIVER	T. BODY	THYROID	KIDNEY	LUNG	GI-LLI
H-3	0.00E+00	4.02E+03	4.02E+03	4.02E+03	4.02E+03	4.02E+03	4.02E+03	0.00E+00	4.02E+03	4.02E+03	4.02E+03	4.02E+03	4.02E+03	4.02E+03
P-32	3.35E+09	1.57E+08	1.29E+08	0.00E+00	0.00E+00	0.00E+00	0.00E+00	3.35E+09	1.57E+08	1.29E+08	0.00E+00	0.00E+00	0.00E+00	9.25E+07
CR-51	0.00E+00	0.00E+00	1.17E+05	6.49E+04	1.77E+04	1.18E+05	6.20E+06	0.00E+00	0.00E+00	1.17E+05	6.49E+04	1.77E+04	1.18E+05	6.20E+06
MN-54	0.00E+00	6.65E+08	1.77E+08	0.00E+00	1.86E+08	0.00E+00	5.58E+08	0.00E+00	6.65E+08	1.77E+08	0.00E+00	1.86E+08	0.00E+00	5.58E+08
FE-55	8.01E+08	4.25E+08	1.32E+08	0.00E+00	0.00E+00	2.40E+08	7.87E+07	8.01E+08	4.25E+08	1.32E+08	0.00E+00	0.00E+00	2.40E+08	7.87E+07
FE-59	3.98E+08	6.44E+08	3.21E+08	0.00E+00	0.00E+00	1.87E+08	6.71E+08	3.98E+08	6.44E+08	3.21E+08	0.00E+00	0.00E+00	1.87E+08	6.71E+08
CO-58	0.00E+00	6.44E+07	1.97E+08	0.00E+00	0.00E+00	0.00E+00	3.76E+08	0.00E+00	6.44E+07	1.97E+08	0.00E+00	0.00E+00	0.00E+00	3.76E+08
CO-60	0.00E+00	3.78E+08	1.12E+09	0.00E+00	0.00E+00	0.00E+00	2.10E+09	0.00E+00	3.78E+08	1.12E+09	0.00E+00	0.00E+00	0.00E+00	2.10E+09
NI-63	3.95E+10	2.11E+09	1.34E+09	0.00E+00	0.00E+00	0.00E+00	1.42E+08	3.95E+10	2.11E+09	1.34E+09	0.00E+00	0.00E+00	0.00E+00	1.42E+08
ZN-65	8.12E+08	2.16E+09	1.35E+09	0.00E+00	1.36E+09	0.00E+00	3.80E+08	8.12E+08	2.16E+09	1.35E+09	0.00E+00	1.36E+09	0.00E+00	3.80E+08
RB-86	0.00E+00	4.51E+08	2.77E+08	0.00E+00	0.00E+00	0.00E+00	2.90E+07	0.00E+00	4.51E+08	2.77E+08	0.00E+00	0.00E+00	0.00E+00	2.90E+07
SR-89	3.60E+10	0.00E+00	1.03E+09	0.00E+00	0.00E+00	0.00E+00	1.39E+09	3.60E+10	0.00E+00	1.03E+09	0.00E+00	0.00E+00	0.00E+00	1.39E+09
SR-90	1.24E+12	0.00E+00	3.15E+11	0.00E+00	0.00E+00	0.00E+00	1.67E+10	1.24E+12	0.00E+00	3.15E+11	0.00E+00	0.00E+00	0.00E+00	1.67E+10
Y-91	1.87E+07	0.00E+00	4.99E+05	0.00E+00	0.00E+00	0.00E+00	2.49E+09	1.87E+07	0.00E+00	4.99E+05	0.00E+00	0.00E+00	0.00E+00	2.49E+09
ZR-95	3.86E+06	8.48E+05	7.55E+05	0.00E+00	1.21E+06	0.00E+00	8.85E+08	3.86E+06	8.48E+05	7.55E+05	0.00E+00	1.21E+06	0.00E+00	8.85E+08
NB-95	4.11E+05	1.60E+05	1.14E+05	0.00E+00	1.50E+05	0.00E+00	2.96E+08	4.11E+05	1.60E+05	1.14E+05	0.00E+00	1.50E+05	0.00E+00	2.96E+08
RU-103	1.53E+07	0.00E+00	5.90E+06	0.00E+00	3.86E+07	0.00E+00	3.97E+08	1.53E+07	0.00E+00	5.90E+06	0.00E+00	3.86E+07	0.00E+00	3.97E+08
RU-106	7.45E+08	0.00E+00	9.30E+07	0.00E+00	1.01E+09	0.00E+00	1.16E+10	7.45E+08	0.00E+00	9.30E+07	0.00E+00	1.01E+09	0.00E+00	1.16E+10
AG-110M	3.21E+07	2.17E+07	1.73E+07	0.00E+00	4.04E+07	0.00E+00	2.58E+09	3.21E+07	2.17E+07	1.73E+07	0.00E+00	4.04E+07	0.00E+00	2.58E+09
TE-125M	3.51E+08	9.50E+07	4.67E+07	9.84E+07	0.00E+00	0.00E+00	3.38E+08	3.51E+08	9.50E+07	4.67E+07	9.84E+07	0.00E+00	0.00E+00	3.38E+08
TE-127M	1.32E+09	3.56E+08	1.57E+08	3.16E+08	3.77E+09	0.00E+00	1.07E+09	1.32E+09	3.56E+08	1.57E+08	3.16E+08	3.77E+09	0.00E+00	1.07E+09
TE-129M	8.40E+08	2.35E+08	1.30E+08	2.71E+08	2.47E+09	0.00E+00	1.02E+09	8.40E+08	2.35E+08	1.30E+08	2.71E+08	2.47E+09	0.00E+00	1.02E+09
I-131	1.43E+08	1.44E+08	8.18E+07	4.76E+10	2.36E+08	0.00E+00	1.28E+07	1.43E+08	1.44E+08	8.18E+07	4.76E+10	2.36E+08	0.00E+00	1.28E+07
I-133	3.53E+06	4.37E+06	1.65E+06	8.12E+08	7.28E+06	0.00E+00	1.76E+06	3.53E+06	4.37E+06	1.65E+06	8.12E+08	7.28E+06	0.00E+00	1.76E+06
CS-134	1.60E+10	2.63E+10	5.55E+09	0.00E+00	8.15E+09	2.93E+09	1.42E+08	1.60E+10	2.63E+10	5.55E+09	0.00E+00	8.15E+09	2.93E+09	1.42E+08
CS-136	8.28E+07	2.28E+08	1.47E+08	0.00E+00	1.21E+08	1.81E+07	8.00E+06	8.28E+07	2.28E+08	1.47E+08	0.00E+00	1.21E+08	1.81E+07	8.00E+06
CS-137	2.39E+10	2.29E+10	3.38E+09	0.00E+00	7.46E+09	2.68E+09	1.43E+08	2.39E+10	2.29E+10	3.38E+09	0.00E+00	7.46E+09	2.68E+09	1.43E+08
BA-140	2.79E+08	2.44E+05	1.63E+07	0.00E+00	7.96E+04	1.46E+05	1.41E+08	2.79E+08	2.44E+05	1.63E+07	0.00E+00	7.96E+04	1.46E+05	1.41E+08
CE-141	6.57E+05	3.28E+05	4.86E+04	0.00E+00	1.44E+05	0.00E+00	4.09E+08	6.57E+05	3.28E+05	4.86E+04	0.00E+00	1.44E+05	0.00E+00	4.09E+08
CE-144	1.27E+08	3.99E+07	6.79E+06	0.00E+00	2.21E+07	0.00E+00	1.04E+10	1.27E+08	3.99E+07	6.79E+06	0.00E+00	2.21E+07	0.00E+00	1.04E+10
PR-143	1.45E+05	4.36E+04	7.21E+03	0.00E+00	2.36E+04	0.00E+00	1.57E+08	1.45E+05	4.36E+04	7.21E+03	0.00E+00	2.36E+04	0.00E+00	1.57E+08
ND-147	7.15E+04	5.79E+04	4.49E+03	0.00E+00	3.18E+04	0.00E+00	9.18E+07	7.15E+04	5.79E+04	4.49E+03	0.00E+00	3.18E+04	0.00E+00	9.18E+07

TABLE 2.4
PATHWAY DOSE FACTORS

NUCLIDE	ORGAN DOSE FACTORS						
	BONE	LIVER	T. BODY	THYROID	KIDNEY	LUNG	GI-LLI
H-3	0.00E+00	0.00E+00	0.00E+00	0.00E+00	0.00E+00	0.00E+00	0.00E+00
P-32	0.00E+00	0.00E+00	0.00E+00	0.00E+00	0.00E+00	0.00E+00	0.00E+00
CR-51	0.00E+00	0.00E+00	0.00E+00	0.00E+00	0.00E+00	0.00E+00	0.00E+00
MN-54	0.00E+00	0.00E+00	0.00E+00	0.00E+00	0.00E+00	0.00E+00	0.00E+00
FE-55	0.00E+00	0.00E+00	0.00E+00	0.00E+00	0.00E+00	0.00E+00	0.00E+00
FE-59	0.00E+00	0.00E+00	0.00E+00	0.00E+00	0.00E+00	0.00E+00	0.00E+00
CO-58	0.00E+00	0.00E+00	0.00E+00	0.00E+00	0.00E+00	0.00E+00	0.00E+00
CO-60	0.00E+00	0.00E+00	0.00E+00	0.00E+00	0.00E+00	0.00E+00	0.00E+00
NI-63	0.00E+00	0.00E+00	0.00E+00	0.00E+00	0.00E+00	0.00E+00	0.00E+00
ZN-65	0.00E+00	0.00E+00	0.00E+00	0.00E+00	0.00E+00	0.00E+00	0.00E+00
RB-86	0.00E+00	0.00E+00	0.00E+00	0.00E+00	0.00E+00	0.00E+00	0.00E+00
SR-89	0.00E+00	0.00E+00	0.00E+00	0.00E+00	0.00E+00	0.00E+00	0.00E+00
SR-90	0.00E+00	0.00E+00	0.00E+00	0.00E+00	0.00E+00	0.00E+00	0.00E+00
Y-91	0.00E+00	0.00E+00	0.00E+00	0.00E+00	0.00E+00	0.00E+00	0.00E+00
ZR-95	0.00E+00	0.00E+00	0.00E+00	0.00E+00	0.00E+00	0.00E+00	0.00E+00
NB-95	0.00E+00	0.00E+00	0.00E+00	0.00E+00	0.00E+00	0.00E+00	0.00E+00
RU-103	0.00E+00	0.00E+00	0.00E+00	0.00E+00	0.00E+00	0.00E+00	0.00E+00
RU-106	0.00E+00	0.00E+00	0.00E+00	0.00E+00	0.00E+00	0.00E+00	0.00E+00
AG-110M	0.00E+00	0.00E+00	0.00E+00	0.00E+00	0.00E+00	0.00E+00	0.00E+00
TE-125M	0.00E+00	0.00E+00	0.00E+00	0.00E+00	0.00E+00	0.00E+00	0.00E+00
TE-127M	0.00E+00	0.00E+00	0.00E+00	0.00E+00	0.00E+00	0.00E+00	0.00E+00
TE-129M	0.00E+00	0.00E+00	0.00E+00	0.00E+00	0.00E+00	0.00E+00	0.00E+00
I-131	0.00E+00	0.00E+00	0.00E+00	0.00E+00	0.00E+00	0.00E+00	0.00E+00
I-133	0.00E+00	0.00E+00	0.00E+00	0.00E+00	0.00E+00	0.00E+00	0.00E+00
CS-134	0.00E+00	0.00E+00	0.00E+00	0.00E+00	0.00E+00	0.00E+00	0.00E+00
CS-136	0.00E+00	0.00E+00	0.00E+00	0.00E+00	0.00E+00	0.00E+00	0.00E+00
CS-137	0.00E+00	0.00E+00	0.00E+00	0.00E+00	0.00E+00	0.00E+00	0.00E+00
BA-140	0.00E+00	0.00E+00	0.00E+00	0.00E+00	0.00E+00	0.00E+00	0.00E+00
CE-141	0.00E+00	0.00E+00	0.00E+00	0.00E+00	0.00E+00	0.00E+00	0.00E+00
CE-144	0.00E+00	0.00E+00	0.00E+00	0.00E+00	0.00E+00	0.00E+00	0.00E+00
PR-143	0.00E+00	0.00E+00	0.00E+00	0.00E+00	0.00E+00	0.00E+00	0.00E+00
ND-147	0.00E+00	0.00E+00	0.00E+00	0.00E+00	0.00E+00	0.00E+00	0.00E+00

TABLE 2.4
PATHWAY DOSE FACTORS

NUCLIDE	ORGAN DOSE FACTORS						
	BONE	LIVER	T. BODY	THYROID	KIDNEY	LUNG	GI-LLI
H-3	0.00E+00	1.26E+03	1.26E+03	1.26E+03	1.26E+03	1.26E+03	1.26E+03
P-32	1.32E+06	7.71E+04	5.01E+04	0.00E+00	0.00E+00	0.00E+00	8.64E+04
CR-51	0.00E+00	0.00E+00	1.00E+02	5.95E+01	2.28E+01	1.44E+04	3.32E+03
MN-54	0.00E+00	3.96E+04	6.30E+03	0.00E+00	9.84E+03	1.40E+06	7.74E+04
FE-55	2.46E+04	1.70E+04	3.94E+03	0.00E+00	0.00E+00	7.21E+04	6.03E+03
FE-59	1.18E+04	2.78E+04	1.06E+04	0.00E+00	0.00E+00	1.02E+06	1.88E+05
CO-58	0.00E+00	1.58E+03	2.07E+03	0.00E+00	0.00E+00	9.28E+05	1.06E+05
CO-60	0.00E+00	1.15E+04	1.48E+04	0.00E+00	0.00E+00	5.97E+06	2.85E+05
NI-63	4.32E+05	3.14E+04	1.45E+04	0.00E+00	0.00E+00	1.78E+05	1.34E+04
ZN-65	3.24E+04	1.03E+05	4.66E+04	0.00E+00	6.90E+04	8.64E+05	5.34E+04
RB-86	0.00E+00	1.35E+05	5.90E+04	0.00E+00	0.00E+00	0.00E+00	1.66E+04
SR-89	3.04E+05	0.00E+00	8.72E+03	0.00E+00	0.00E+00	1.40E+06	3.50E+05
SR-90	9.92E+07	0.00E+00	6.10E+06	0.00E+00	0.00E+00	9.60E+06	7.22E+05
Y-91	4.62E+05	0.00E+00	1.24E+04	0.00E+00	0.00E+00	1.70E+06	3.85E+05
ZR-95	1.07E+05	3.44E+04	2.33E+04	0.00E+00	5.42E+04	1.77E+06	1.50E+05
NB-95	1.41E+04	7.82E+03	4.21E+03	0.00E+00	7.74E+03	5.05E+05	1.04E+05
RU-103	1.53E+03	0.00E+00	6.58E+02	0.00E+00	5.83E+03	5.05E+05	1.10E+05
RU-106	6.91E+04	0.00E+00	8.72E+03	0.00E+00	1.34E+05	9.36E+06	9.12E+05
AG-110M	1.08E+04	1.00E+04	5.94E+03	0.00E+00	1.97E+04	4.63E+06	3.02E+05
TE-125M	3.42E+03	1.58E+03	4.67E+02	1.05E+03	1.24E+04	3.14E+05	7.06E+04
TE-127M	1.26E+04	5.77E+03	1.57E+03	3.29E+03	4.58E+04	9.60E+05	1.50E+05
TE-129M	9.76E+03	4.67E+03	1.58E+03	3.44E+03	3.66E+04	1.16E+06	3.83E+05
I-131	2.52E+04	3.58E+04	2.05E+04	1.19E+07	6.13E+04	0.00E+00	6.28E+03
I-133	8.64E+03	1.48E+04	4.52E+03	2.15E+06	2.58E+04	0.00E+00	8.88E+03
CS-134	3.73E+05	8.48E+05	7.28E+05	0.00E+00	2.87E+05	9.76E+04	1.04E+04
CS-136	3.90E+04	1.46E+05	1.10E+05	0.00E+00	8.56E+04	1.20E+04	1.17E+04
CS-137	4.78E+05	6.21E+05	4.28E+05	0.00E+00	2.22E+05	7.52E+04	8.40E+03
BA-140	3.90E+04	4.90E+01	2.57E+03	0.00E+00	1.67E+01	1.27E+06	2.18E+05
CE-141	1.99E+04	1.35E+04	1.53E+03	0.00E+00	6.26E+03	3.62E+05	1.20E+05
CE-144	3.43E+06	1.43E+06	1.84E+05	0.00E+00	8.48E+05	7.78E+06	8.16E+05
PR-143	9.36E+03	3.75E+03	4.64E+02	0.00E+00	2.16E+03	2.81E+05	2.00E+05
ND-147	5.27E+03	6.10E+03	3.65E+02	0.00E+00	3.56E+03	2.21E+05	1.73E+05

TABLE 2.4
PATHWAY DOSE FACTORS

NUCLIDE	ORGAN DOSE FACTORS						
	BONE	LIVER	T. BODY	THYROID	KIDNEY	LUNG	GI-LLI
H-3	0.00E+00	1.27E+03	1.27E+03	1.27E+03	1.27E+03	1.27E+03	1.27E+03
P-32	1.89E+06	1.10E+05	7.16E+04	0.00E+00	0.00E+00	0.00E+00	9.28E+04
CR-51	0.00E+00	0.00E+00	1.32E+02	7.50E+01	3.07E+01	2.10E+04	3.00E+03
MN-54	0.00E+00	5.11E+04	8.40E+03	0.00E+00	1.27E+04	1.98E+06	6.68E+04
FE-55	3.34E+04	2.38E+04	5.54E+03	0.00E+00	0.00E+00	1.24E+05	6.39E+03
FE-59	1.59E+04	3.70E+04	1.43E+04	0.00E+00	0.00E+00	1.53E+06	1.78E+05
CO-58	0.00E+00	2.07E+03	2.78E+03	0.00E+00	0.00E+00	1.34E+06	9.52E+04
CO-60	0.00E+00	1.51E+04	1.98E+04	0.00E+00	0.00E+00	8.72E+06	2.59E+05
NI-63	5.80E+05	4.34E+04	1.98E+04	0.00E+00	0.00E+00	3.07E+05	1.42E+04
ZN-65	3.86E+04	1.34E+05	6.24E+04	0.00E+00	8.64E+04	1.24E+06	4.66E+04
RB-86	0.00E+00	1.90E+05	8.40E+04	0.00E+00	0.00E+00	0.00E+00	1.77E+04
SR-89	4.34E+05	0.00E+00	1.25E+04	0.00E+00	0.00E+00	2.42E+06	3.71E+05
SR-90	1.08E+08	0.00E+00	6.68E+06	0.00E+00	0.00E+00	1.65E+07	7.65E+05
Y-91	6.61E+05	0.00E+00	1.77E+04	0.00E+00	0.00E+00	2.94E+06	4.09E+05
ZR-95	1.46E+05	4.58E+04	3.15E+04	0.00E+00	6.74E+04	2.69E+06	1.49E+05
NB-95	1.86E+04	1.03E+04	5.66E+03	0.00E+00	1.00E+04	7.51E+05	9.68E+04
RU-103	2.10E+03	0.00E+00	8.96E+02	0.00E+00	7.43E+03	7.83E+05	1.09E+05
RU-106	9.84E+04	0.00E+00	1.24E+04	0.00E+00	1.90E+05	1.61E+07	9.60E+05
AG-110M	1.38E+04	1.31E+04	7.99E+03	0.00E+00	2.50E+04	6.75E+06	2.73E+05
TE-125M	4.88E+03	2.24E+03	6.67E+02	1.40E+03	0.00E+00	5.36E+05	7.50E+04
TE-127M	1.80E+04	8.16E+03	2.18E+03	4.38E+03	6.54E+04	1.66E+06	1.59E+05
TE-129M	1.39E+04	6.58E+03	2.25E+03	4.58E+03	5.19E+04	1.98E+06	4.05E+05
I-131	3.54E+04	4.91E+04	2.64E+04	1.46E+07	8.40E+04	0.00E+00	6.49E+03
I-133	1.22E+04	2.05E+04	6.22E+03	2.92E+06	3.59E+04	0.00E+00	1.03E+04
CS-134	5.02E+05	1.13E+06	5.49E+05	0.00E+00	3.75E+05	1.46E+05	9.76E+03
CS-136	5.15E+04	1.94E+05	1.37E+05	0.00E+00	1.10E+05	1.78E+04	1.09E+04
CS-137	6.70E+05	8.48E+05	3.11E+05	0.00E+00	3.04E+05	1.21E+05	8.48E+03
BA-140	5.47E+04	6.70E+01	3.52E+03	0.00E+00	2.28E+01	2.03E+06	2.29E+05
CE-141	2.84E+04	1.90E+04	2.17E+03	0.00E+00	8.88E+03	6.14E+05	1.26E+05
CE-144	4.89E+06	2.02E+06	2.62E+05	0.00E+00	1.21E+06	1.34E+07	8.64E+05
PR-143	1.34E+04	5.31E+03	6.62E+02	0.00E+00	3.09E+03	4.83E+05	2.14E+05
ND-147	7.86E+03	8.56E+03	5.13E+02	0.00E+00	5.02E+03	3.72E+05	1.82E+05

TABLE 2.4
PATHWAY DOSE FACTORS

NUCLIDE	AGE GROUP: CHILD							PATHWAY: INHALATION						
	ORGAN DOSE FACTORS													
	BONE	LIVER	T. BODY	THYROID	KIDNEY	LUNG	GI-LLI	BONE	LIVER	T. BODY	THYROID	KIDNEY	LUNG	GI-LLI
H-3	0.00E+00	1.12E+03	1.12E+03	1.12E+03	1.12E+03	1.12E+03	1.12E+03	0.00E+00	1.12E+03	1.12E+03	1.12E+03	1.12E+03	1.12E+03	1.12E+03
P-32	2.60E+06	1.14E+05	9.88E+04	0.00E+00	0.00E+00	0.00E+00	0.00E+00	2.60E+06	1.14E+05	9.88E+04	0.00E+00	0.00E+00	0.00E+00	4.22E+04
CR-51	0.00E+00	0.00E+00	1.54E+02	8.55E+01	2.43E+01	1.70E+04	1.08E+03	0.00E+00	0.00E+00	1.54E+02	8.55E+01	2.43E+01	1.70E+04	1.08E+03
MN-54	0.00E+00	4.29E+04	9.51E+03	0.00E+00	1.00E+04	1.58E+06	2.29E+04	0.00E+00	4.29E+04	9.51E+03	0.00E+00	1.00E+04	1.58E+06	2.29E+04
FE-55	4.74E+04	2.52E+04	7.77E+03	0.00E+00	0.00E+00	1.11E+05	2.87E+03	4.74E+04	2.52E+04	7.77E+03	0.00E+00	0.00E+00	1.11E+05	2.87E+03
FE-59	2.07E+04	3.34E+04	1.67E+04	0.00E+00	0.00E+00	1.27E+06	7.07E+04	2.07E+04	3.34E+04	1.67E+04	0.00E+00	0.00E+00	1.27E+06	7.07E+04
CO-58	0.00E+00	1.77E+03	3.16E+03	0.00E+00	0.00E+00	1.11E+06	3.44E+04	0.00E+00	1.77E+03	3.16E+03	0.00E+00	0.00E+00	1.11E+06	3.44E+04
CO-60	0.00E+00	1.31E+04	2.26E+04	0.00E+00	0.00E+00	7.07E+06	9.62E+04	0.00E+00	1.31E+04	2.26E+04	0.00E+00	0.00E+00	7.07E+06	9.62E+04
NI-63	8.21E+05	4.63E+04	2.80E+04	0.00E+00	0.00E+00	2.75E+05	6.33E+03	8.21E+05	4.63E+04	2.80E+04	0.00E+00	0.00E+00	2.75E+05	6.33E+03
ZN-65	4.26E+04	1.13E+05	7.03E+04	0.00E+00	7.14E+04	9.95E+05	1.63E+04	4.26E+04	1.13E+05	7.03E+04	0.00E+00	7.14E+04	9.95E+05	1.63E+04
RB-86	0.00E+00	1.98E+05	1.14E+05	0.00E+00	0.00E+00	0.00E+00	7.99E+03	0.00E+00	1.98E+05	1.14E+05	0.00E+00	0.00E+00	0.00E+00	7.99E+03
SR-89	5.99E+05	0.00E+00	1.72E+04	0.00E+00	0.00E+00	2.16E+06	1.67E+05	5.99E+05	0.00E+00	1.72E+04	0.00E+00	0.00E+00	2.16E+06	1.67E+05
SR-90	1.01E+08	0.00E+00	6.44E+06	0.00E+00	0.00E+00	1.48E+07	3.43E+05	1.01E+08	0.00E+00	6.44E+06	0.00E+00	0.00E+00	1.48E+07	3.43E+05
Y-91	9.14E+05	0.00E+00	2.44E+04	0.00E+00	0.00E+00	2.63E+06	1.84E+05	9.14E+05	0.00E+00	2.44E+04	0.00E+00	0.00E+00	2.63E+06	1.84E+05
ZR-95	1.90E+05	4.18E+04	3.70E+04	0.00E+00	5.96E+04	2.23E+06	6.11E+04	1.90E+05	4.18E+04	3.70E+04	0.00E+00	5.96E+04	2.23E+06	6.11E+04
NB-95	2.35E+04	9.18E+03	6.55E+03	0.00E+00	8.62E+03	6.14E+05	3.70E+04	2.35E+04	9.18E+03	6.55E+03	0.00E+00	8.62E+03	6.14E+05	3.70E+04
RU-103	2.79E+03	0.00E+00	1.07E+03	0.00E+00	7.03E+03	6.62E+05	4.48E+04	2.79E+03	0.00E+00	1.07E+03	0.00E+00	7.03E+03	6.62E+05	4.48E+04
RU-106	1.36E+05	0.00E+00	1.69E+04	0.00E+00	1.84E+05	1.43E+07	4.29E+05	1.36E+05	0.00E+00	1.69E+04	0.00E+00	1.84E+05	1.43E+07	4.29E+05
AG-110M	1.69E+04	1.14E+04	9.14E+03	0.00E+00	2.12E+04	5.48E+06	1.00E+05	1.69E+04	1.14E+04	9.14E+03	0.00E+00	2.12E+04	5.48E+06	1.00E+05
TE-125M	6.73E+03	2.33E+03	9.14E+02	1.92E+03	0.00E+00	4.77E+05	3.38E+04	6.73E+03	2.33E+03	9.14E+02	1.92E+03	0.00E+00	4.77E+05	3.38E+04
TE-127M	2.49E+04	8.55E+03	3.02E+03	6.07E+03	6.36E+04	1.48E+06	7.14E+04	2.49E+04	8.55E+03	3.02E+03	6.07E+03	6.36E+04	1.48E+06	7.14E+04
TE-129M	1.92E+04	6.85E+03	3.04E+03	6.33E+03	5.03E+04	1.76E+06	1.82E+05	1.92E+04	6.85E+03	3.04E+03	6.33E+03	5.03E+04	1.76E+06	1.82E+05
I-131	4.81E+04	4.81E+04	2.73E+04	1.62E+07	7.88E+04	0.00E+00	2.84E+03	4.81E+04	4.81E+04	2.73E+04	1.62E+07	7.88E+04	0.00E+00	2.84E+03
I-133	1.66E+04	2.03E+04	7.70E+03	3.85E+06	3.38E+04	0.00E+00	5.48E+03	1.66E+04	2.03E+04	7.70E+03	3.85E+06	3.38E+04	0.00E+00	5.48E+03
CS-134	6.51E+05	1.01E+06	2.25E+05	0.00E+00	3.30E+05	1.21E+05	3.85E+03	6.51E+05	1.01E+06	2.25E+05	0.00E+00	3.30E+05	1.21E+05	3.85E+03
CS-136	6.51E+04	1.71E+05	1.16E+05	0.00E+00	9.55E+04	1.45E+04	4.18E+03	6.51E+04	1.71E+05	1.16E+05	0.00E+00	9.55E+04	1.45E+04	4.18E+03
CS-137	9.07E+05	8.25E+05	1.28E+05	0.00E+00	2.82E+05	1.04E+05	3.62E+03	9.07E+05	8.25E+05	1.28E+05	0.00E+00	2.82E+05	1.04E+05	3.62E+03
BA-140	7.40E+04	6.48E+01	4.33E+03	0.00E+00	2.11E+01	1.74E+06	1.02E+05	7.40E+04	6.48E+01	4.33E+03	0.00E+00	2.11E+01	1.74E+06	1.02E+05
CE-141	3.92E+04	1.95E+04	2.90E+03	0.00E+00	8.55E+03	5.44E+05	5.66E+04	3.92E+04	1.95E+04	2.90E+03	0.00E+00	8.55E+03	5.44E+05	5.66E+04
CE-144	6.77E+06	2.12E+06	3.61E+05	0.00E+00	1.17E+06	1.20E+07	3.89E+05	6.77E+06	2.12E+06	3.61E+05	0.00E+00	1.17E+06	1.20E+07	3.89E+05
PR-143	1.85E+04	5.55E+03	9.14E+02	0.00E+00	3.00E+03	4.33E+05	9.73E+04	1.85E+04	5.55E+03	9.14E+02	0.00E+00	3.00E+03	4.33E+05	9.73E+04
ND-147	1.08E+04	8.73E+03	6.81E+02	0.00E+00	4.81E+03	3.28E+05	8.21E+04	1.08E+04	8.73E+03	6.81E+02	0.00E+00	4.81E+03	3.28E+05	8.21E+04

TABLE 2.4
PATHWAY DOSE FACTORS

NUCLIDE	AGE GROUP: INFANT							PATHWAY: INHALATION						
	ORGAN DOSE FACTORS													
	BONE	LIVER	T. BODY	THYROID	KIDNEY	LUNG	GI-LLI	BONE	LIVER	T. BODY	THYROID	KIDNEY	LUNG	GI-LLI
H-3	0.00E+00	6.47E+02	6.47E+02	6.47E+02	6.47E+02	6.47E+02	6.47E+02	0.00E+00	6.47E+02	6.47E+02	6.47E+02	6.47E+02	6.47E+02	6.47E+02
P-32	2.03E+06	1.12E+05	7.74E+04	0.00E+00	0.00E+00	0.00E+00	0.00E+00	2.03E+06	1.12E+05	7.74E+04	0.00E+00	0.00E+00	0.00E+00	1.61E+04
CR-51	0.00E+00	0.00E+00	8.95E+01	5.75E+01	1.32E+01	1.28E+04	3.57E+02	0.00E+00	0.00E+00	8.95E+01	5.75E+01	1.32E+01	1.28E+04	3.57E+02
MN-54	0.00E+00	2.53E+04	4.98E+03	0.00E+00	4.98E+03	1.00E+06	7.06E+03	0.00E+00	2.53E+04	4.98E+03	0.00E+00	4.98E+03	1.00E+06	7.06E+03
FE-55	1.97E+04	1.17E+04	3.33E+03	0.00E+00	0.00E+00	8.69E+04	1.09E+03	1.97E+04	1.17E+04	3.33E+03	0.00E+00	0.00E+00	8.69E+04	1.09E+03
FE-59	1.36E+04	2.35E+04	9.48E+03	0.00E+00	0.00E+00	1.02E+06	2.48E+04	1.36E+04	2.35E+04	9.48E+03	0.00E+00	0.00E+00	1.02E+06	2.48E+04
CO-58	0.00E+00	1.22E+03	1.82E+03	0.00E+00	0.00E+00	7.77E+05	1.11E+04	0.00E+00	1.22E+03	1.82E+03	0.00E+00	0.00E+00	7.77E+05	1.11E+04
CO-60	0.00E+00	8.02E+03	1.18E+04	0.00E+00	0.00E+00	4.51E+06	3.19E+04	0.00E+00	8.02E+03	1.18E+04	0.00E+00	0.00E+00	4.51E+06	3.19E+04
NI-63	3.39E+05	2.04E+04	1.16E+04	0.00E+00	0.00E+00	2.09E+05	2.42E+03	3.39E+05	2.04E+04	1.16E+04	0.00E+00	0.00E+00	2.09E+05	2.42E+03
ZN-65	1.93E+04	6.26E+04	3.11E+04	0.00E+00	3.25E+04	6.47E+05	5.14E+04	1.93E+04	6.26E+04	3.11E+04	0.00E+00	3.25E+04	6.47E+05	5.14E+04
RB-86	0.00E+00	1.90E+05	8.82E+04	0.00E+00	0.00E+00	0.00E+00	3.04E+03	0.00E+00	1.90E+05	8.82E+04	0.00E+00	0.00E+00	0.00E+00	3.04E+03
SR-89	3.98E+05	0.00E+00	1.14E+04	0.00E+00	0.00E+00	2.03E+06	6.40E+04	3.98E+05	0.00E+00	1.14E+04	0.00E+00	0.00E+00	2.03E+06	6.40E+04
SR-90	4.09E+07	0.00E+00	2.59E+06	0.00E+00	0.00E+00	1.12E+07	1.31E+05	4.09E+07	0.00E+00	2.59E+06	0.00E+00	0.00E+00	1.12E+07	1.31E+05
Y-91	5.88E+05	0.00E+00	1.57E+04	0.00E+00	0.00E+00	2.45E+06	7.03E+04	5.88E+05	0.00E+00	1.57E+04	0.00E+00	0.00E+00	2.45E+06	7.03E+04
ZR-95	1.15E+05	2.79E+04	2.03E+04	0.00E+00	3.11E+04	1.75E+06	2.17E+04	1.15E+05	2.79E+04	2.03E+04	0.00E+00	3.11E+04	1.75E+06	2.17E+04
NB-95	1.57E+04	6.43E+03	3.78E+03	0.00E+00	4.72E+03	4.79E+05	1.27E+04	1.57E+04	6.43E+03	3.78E+03	0.00E+00	4.72E+03	4.79E+05	1.27E+04
RU-103	2.02E+03	0.00E+00	6.79E+02	0.00E+00	4.24E+03	5.52E+05	1.61E+04	2.02E+03	0.00E+00	6.79E+02	0.00E+00	4.24E+03	5.52E+05	1.61E+04
RU-106	8.68E+04	0.00E+00	1.09E+04	0.00E+00	1.07E+05	1.16E+07	1.64E+05	8.68E+04	0.00E+00	1.09E+04	0.00E+00	1.07E+05	1.16E+07	1.64E+05
AG-110M	9.98E+03	7.22E+03	5.00E+03	0.00E+00	1.09E+04	3.67E+06	3.30E+04	9.98E+03	7.22E+03	5.00E+03	0.00E+00	1.09E+04	3.67E+06	3.30E+04
TE-125M	4.76E+03	1.99E+03	6.58E+02	1.62E+03	0.00E+00	4.47E+05	1.29E+04	4.76E+03	1.99E+03	6.58E+02	1.62E+03	0.00E+00	4.47E+05	1.29E+04
TE-127M	1.67E+04	6.90E+03	2.07E+03	4.87E+03	3.75E+04	1.31E+06	2.73E+04	1.67E+04	6.90E+03	2.07E+03	4.87E+03	3.75E+04	1.31E+06	2.73E+04
TE-129M	1.41E+04	6.09E+03	2.23E+03	5.47E+03	3.18E+04	1.68E+06	6.90E+04	1.41E+04	6.09E+03	2.23E+03	5.47E+03	3.18E+04	1.68E+06	6.90E+04
I-131	3.79E+04	4.44E+04	1.96E+04	1.48E+07	5.18E+04	0.00E+00	1.06E+03	3.79E+04	4.44E+04	1.96E+04	1.48E+07	5.18E+04	0.00E+00	1.06E+03
I-133	1.32E+04	1.92E+04	5.60E+03	3.56E+06	2.24E+04	0.00E+00	2.16E+03	1.32E+04	1.92E+04	5.60E+03	3.56E+06	2.24E+04	0.00E+00	2.16E+03
CS-134	3.96E+05	7.03E+05	7.45E+04	0.00E+00	1.90E+05	7.97E+04	1.33E+03	3.96E+05	7.03E+05	7.45E+04	0.00E+00	1.90E+05	7.97E+04	1.33E+03
CS-136	4.83E+04	1.35E+05	5.29E+04	0.00E+00	5.64E+04	1.18E+04	1.43E+03	4.83E+04	1.35E+05	5.29E+04	0.00E+00	5.64E+04	1.18E+04	1.43E+03
CS-137	5.49E+05	6.12E+05	4.55E+04	0.00E+00	1.72E+05	7.13E+04	1.33E+03	5.49E+05	6.12E+05	4.55E+04	0.00E+00	1.72E+05	7.13E+04	1.33E+03
BA-140	5.60E+04	5.60E+01	2.90E+03	0.00E+00	1.34E+01	1.60E+06	3.84E+04	5.60E+04	5.60E+01	2.90E+03	0.00E+00	1.34E+01	1.60E+06	3.84E+04
CE-141	2.77E+04	1.67E+04	1.99E+03	0.00E+00	5.25E+03	5.17E+05	2.16E+04	2.77E+04	1.67E+04	1.99E+03	0.00E+00	5.25E+03	5.17E+05	2.16E+04
CE-144	3.19E+06	1.21E+06	1.76E+05	0.00E+00	5.38E+05	9.84E+06	1.48E+05	3.19E+06	1.21E+06	1.76E+05	0.00E+00	5.38E+05	9.84E+06	1.48E+05
PR-143	1.40E+04	5.24E+03	6.99E+02	0.00E+00	1.97E+03	4.33E+05	3.72E+04	1.40E+04	5.24E+03	6.99E+02	0.00E+00	1.97E+03	4.33E+05	3.72E+04
ND-147	7.94E+03	8.13E+03	5.00E+02	0.00E+00	3.15E+03	3.22E+05	3.12E+04	7.94E+03	8.13E+03	5.00E+02	0.00E+00	3.15E+03	3.22E+05	3.12E+04

TABLE 2.5

(Sheet 1)

CONTROLLING RECEPTOR PATHWAYS AND LOCATIONS (NOTE 1), AND
ATMOSPHERIC DISPERSION PARAMETERS (FOR DOSE CALCULATIONS
REQUIRED BY RADIOLOGICAL EFFLUENT CONTROL 3/4.11.2.3)

TABLE RELOCATED;

CURRENT INFORMATION LISTED AND MAINTAINED

CURRENT IN RESULTS OF ANNUAL LAND USE CENSUS

GASEOUS WASTE PROCESSING SYSTEM

FIGURE 2.1
(Simplified diagram)

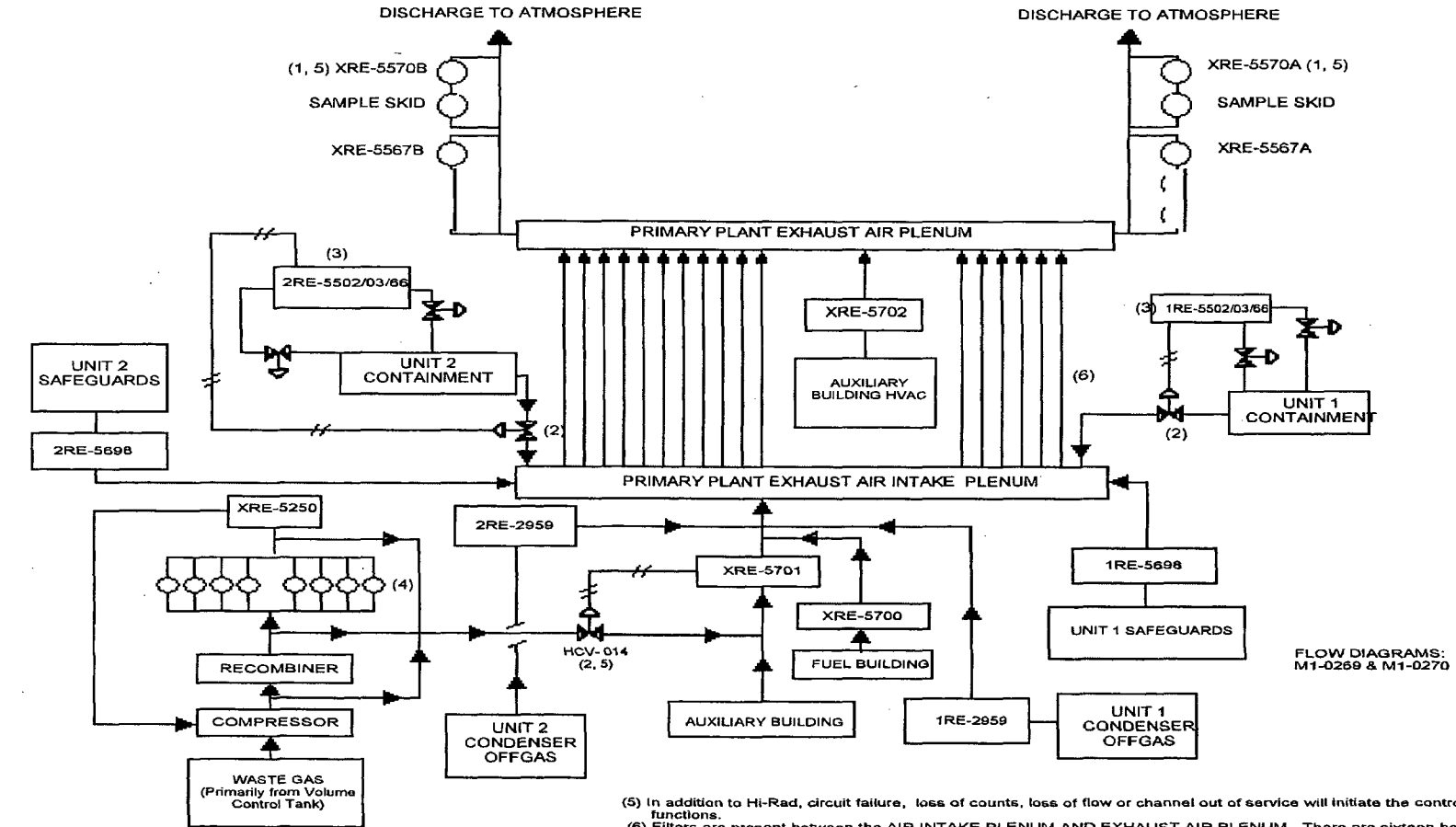

FLOW DIAGRAMS:
M1-0269 & M1-0270

- (1) Wide Range Gas Monitor, Hi-Rad Indication closes valve HCV-014 (Waste Gas Release).
- (2) Hi-Rad indication by monitor closes valve.
- (3) Hi-Rad indication initiates containment isolation.
- (4) Eight gaseous decay tanks can be individually purged (There are two additional tanks for shutdown).

(5) In addition to Hi-Rad, circuit failure, loss of counts, loss of flow or channel out of service will initiate the control functions.

(6) Filters are present between the AIR INTAKE PLENUM AND EXHAUST AIR PLENUM. There are sixteen banks of filters divided into TRAIN A and TRAIN B. Each bank consists of a carbon filter, 2HEPA filter, a carbon filter, and a HEPA filter in series.

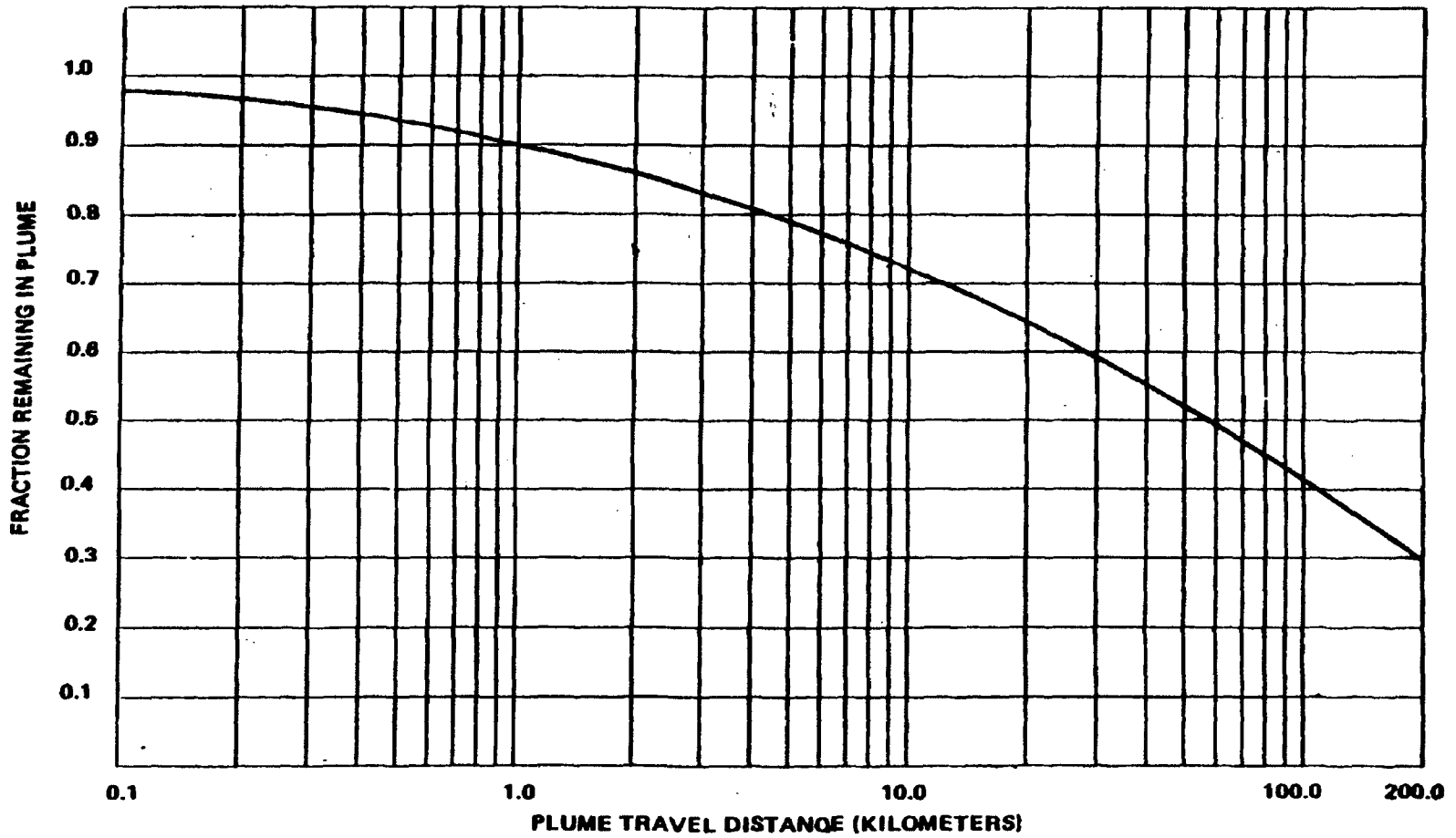
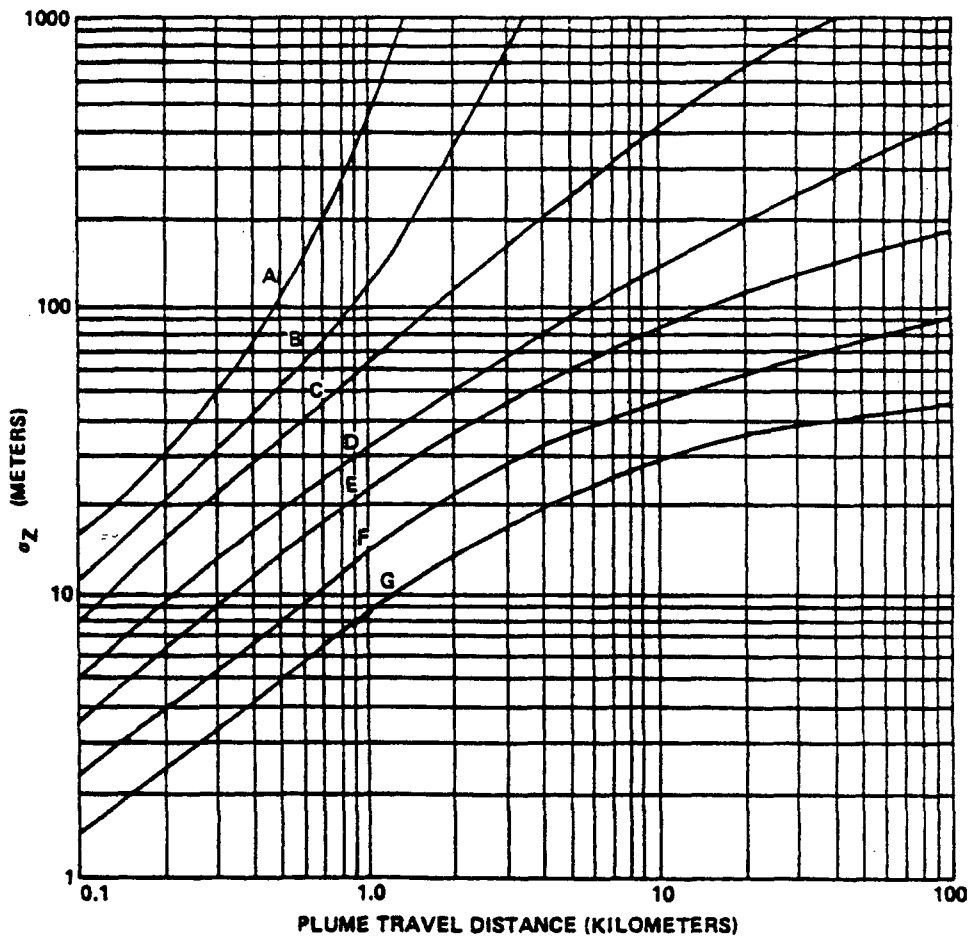

Figure 2.2
 Plume Depletion Effect for Ground-Level Releases (All Atmospheric Stability Classes)



Vertical Standard Deviation of Material in a Plume (Letters denote Pasquill Stability Class)

NOTE: THESE ARE STANDARD RELATIONSHIPS AND MAY HAVE TO BE MODIFIED FOR CERTAIN TYPES OF TERRAIN AND/OR CLIMATIC CONDITIONS (E.G., VALLEY, DESERT, OVER WATER)

Figure 2.3

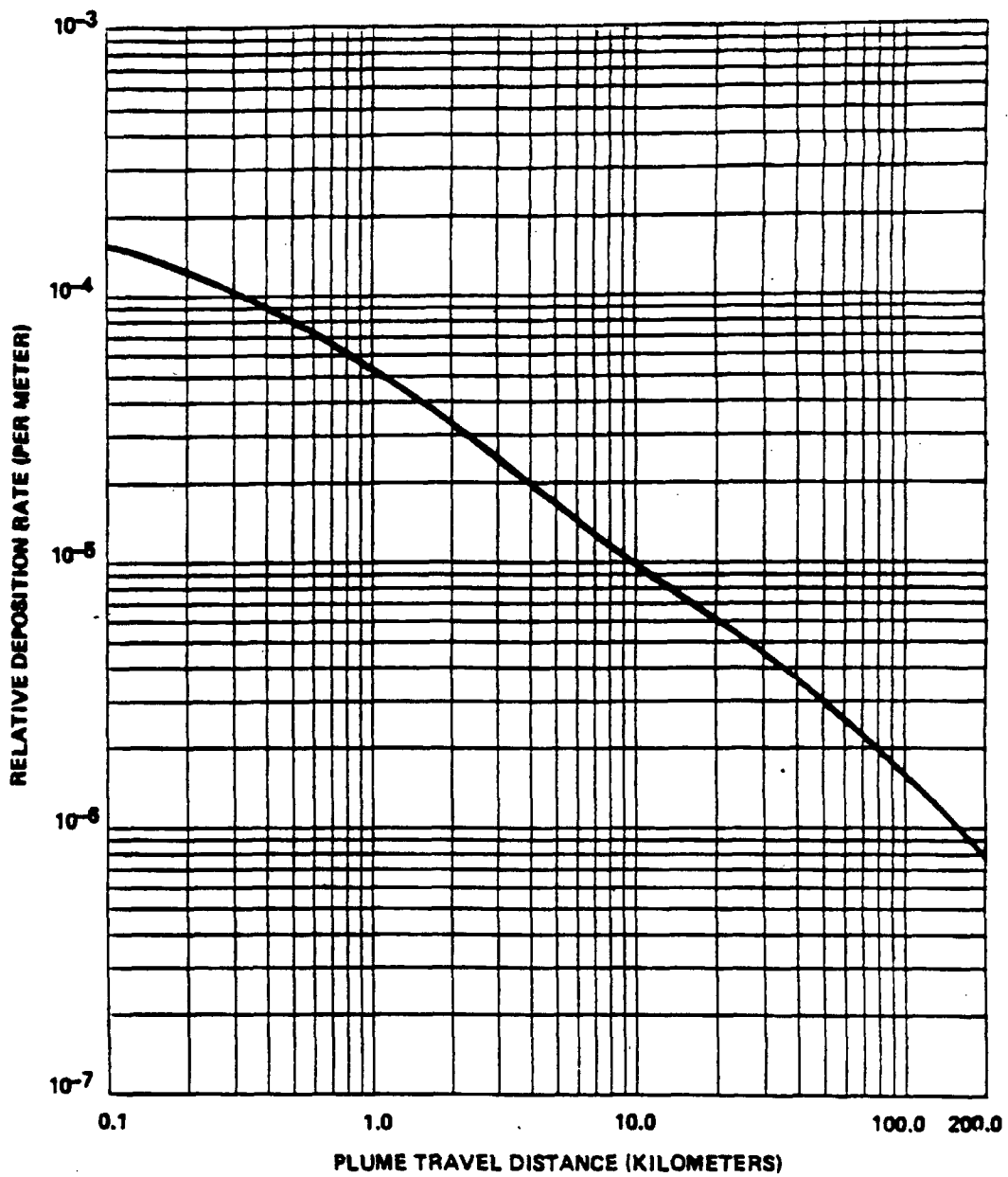

Relative Deposition for Ground-Level Releases (All Atmospheric Stability Classes)

Figure 2.4

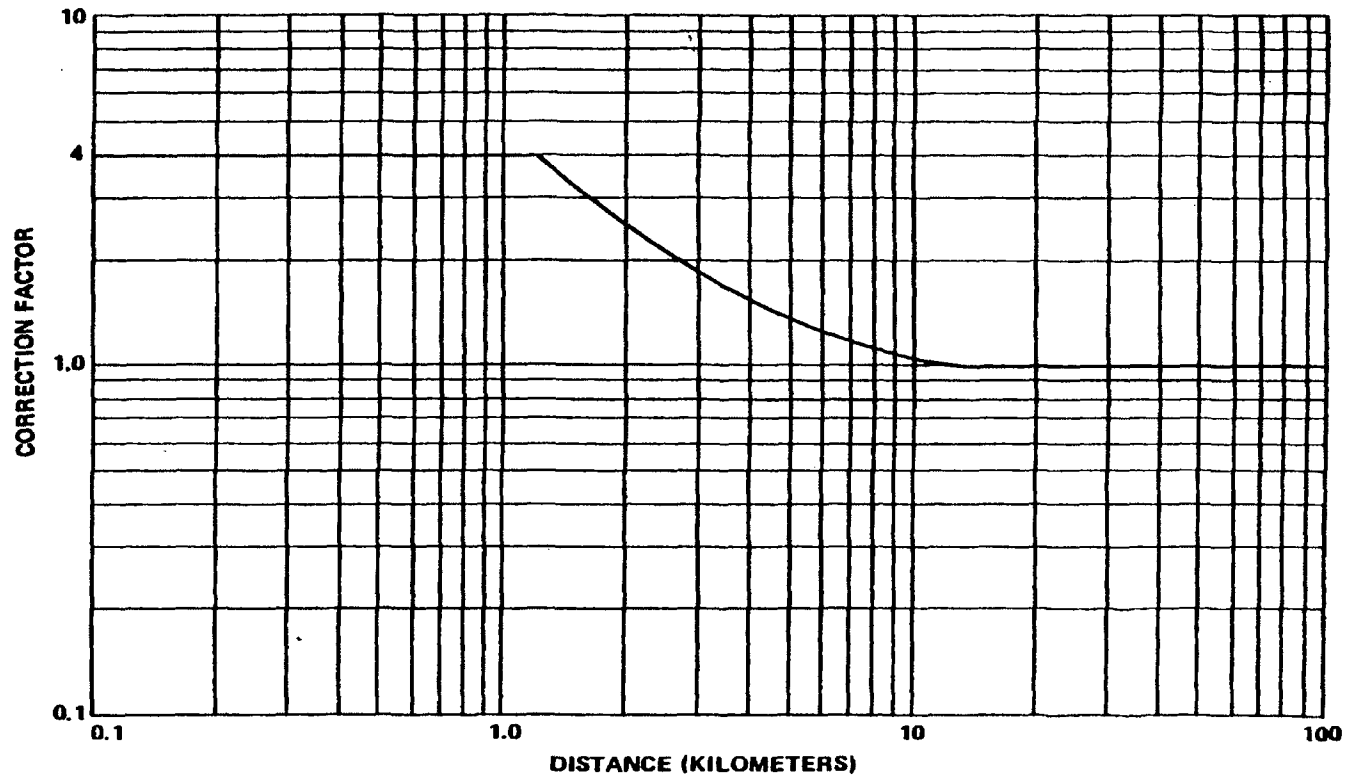

Open Terrain Correction Factor

Figure 2.5

SECTION 3.0

RADIOLOGICAL ENVIRONMENTAL MONITORING

3.1 SAMPLING LOCATIONS

Sampling locations as required in Radiological Effluent Control 3/4.12.1, Table 3.12-1 are listed and maintained current in the results of the annual Land Use Census.

NOTE: For the purpose of implementing Radiological Effluent Control 3/4.12.1, sampling locations will be modified as required to reflect the findings of the Land Use Census. Dose calculations used in making this determination will be performed as specified in Section 2.5.

The sampling locations maintained in the results of the annual Land Use Census are the minimum locations required for compliance with Radiological Effluent Control 3/4.12.1. If desired, additional locations may be monitored as special studies to evaluate potential pathways of exposure without adding such locations to the monitoring program.

3.2 INTERLABORATORY COMPARISON PROGRAM

For the purpose of implementing Radiological Effluent Control 3/4.12.3, TXU Power has contracted with an outside laboratory to provide radiological environmental analytical services with required participation in an Interlaboratory Comparison Program. The Interlaboratory Comparison Program is conducted by a third-party laboratory which supplies environmental-type samples (e.g., milk or water) containing concentrations of radionuclides known to the issuing laboratory but not to the participant laboratories. The purpose of the program is to provide an independent check on the participant laboratory's analytical procedures and to alert the participants to any possible problems. Participant laboratories measure the concentrations of specified radionuclides and report them to the issuing laboratory. Several months later, the issuing laboratory reports the known values to the participant laboratories and specifies control limits. Results consistently higher or lower than the known values or outside the control limits indicate a need to check the instruments or procedures used. TXU Power's contracted outside laboratory participates in an environmental sample crosscheck program for representative sample media. The results of the program are included in the Annual Radiological Environmental Operating Report, as required by CPSES ODCM Section 6.9.1.3.

TABLE 3.1
ENVIRONMENTAL SAMPLING LOCATIONS

TABLE RELOCATED;
ENVIRONMENTAL SAMPLING LOCATIONS ARE LISTED AND MAINTAINED
CURRENT IN THE RESULTS OF THE ANNUAL
LAND USE CENSUS

FIGURE 3.1
RADIOLOGICAL ENVIRONMENTAL
MONITORING LOCATIONS

FIGURE RELOCATED;

RADIOLOGICAL ENVIRONMENTAL MONITORING LOCATIONS ARE LISTED
AND MAINTAINED CURRENT IN THE RESULTS OF THE ANNUAL
LAND USE CENSUS

APPENDIX A
PATHWAY DOSE RATE PARAMETER

$$P_i (\text{inhalation}) = K' (\text{BR}) \text{DFA}_i \quad [\text{Eq. A-1}]$$

Where:

P_i = Pathway dose rate parameter for radionuclide, i , (other than noble gases) for the inhalation pathway, in mrem/yr per microcurie/ m^3 . The dose factors are based on the critical individual organ for the child age group.

K' = Conversion factor, 10^6 pCi/microcurie

BR = 3700 m^3/yr , breathing rate for child (Ref. 2, Table E-5)

DFA_i = Maximum organ inhalation dose factor for the child age group for the i th radionuclide (mRem/pCi). Values are taken from Table E-9, Reg. Guide 1.109 (Ref. 2).

Resolution of the units yields:

$$P_i (\text{inhalation}) = 3.7 \times 10^9 \text{DFA}_i (\text{mRem/yr per uCi/m}^3) \quad [\text{Eq. A-2}]$$

The latest NRC Guidance has deleted the requirement to determine P_i (ground plane) and P_i (food). In addition, the critical age group has been changed from infant to child.

APPENDIX B
INHALATION PATHWAY DOSE FACTOR ($R_{i,a,o}^I$)

$$R_{i,a,o}^I = k^I (BR) (DFA_{i,a,o}) \text{ (mrem/yr per microcurie/m}^3\text{)} \quad [\text{Eq. B-1}]$$

Where:

- k^I = Conversion factor, 10^6 pCi/microcurie
- BR = Breathing rate, 1400, 3700, 8000, and 8000 m^3/yr for infant, child, teenager, and adult age groups, respectively. (Ref. 2, Table E-5)
- $DFA_{i,a,o}$ = Inhalation dose factor for organ, o, of the receptor of a given age group, a, and for the i th radionuclide, in mrem/pCi. The total body is considered as an organ in the selection of $DFA_{i,a,o}$. Values are taken from Tables E-7 through E-10, Reg. Guide 1.109 (Ref. 2).

APPENDIX C
GROUND PLANE PATHWAY DOSE FACTOR (R_i^G)

$$R_i^G = k' k'' (SF) DFG_i \left[(1 - e^{-\lambda_i t}) / \lambda_i \right] \quad [\text{Eq. C-1}]$$

Where:

- k' = Conversion factor, 10^6 pCi/microcurie
- k'' = Conversion factor, 8760 hr/yr
- λ_i = Decay constant for the i th radionuclide, sec^{-1}
- t = Exposure time (this calculation assumes that decay is the only operating removal mechanism) 4.73×10^8 sec. (15 yrs)
- DFG_i = Ground plane dose conversion factor for the i th radionuclide (mrem/hr per pCi/m^2). Values are taken from Table E-6, Reg. Guide 1.109 (Ref. 2). These values apply to all age groups. Dose factors are provided for the total body and skin only. Doses to all other organs are assumed equal to the total body dose.
- SF = 0.7, shielding factor, from Table E-15, Reg. Guide 1.109 (Ref. 2).

APPENDIX D
GRASS-COW-MILK PATHWAY DOSE FACTOR ($R_{i,a,o}^C$)

$$R_{i,a,o}^C = k'[(Q_F \times U_{AP})/(\lambda_1 + \lambda_W)] \times (F_m) \times (r) \times (DFL_{i,a,o}) \times [((f_p \times f_s)/Y_p) + ((1 - f_p \times f_s)e^{-\lambda_i t_h})/Y_s] e^{-\lambda_i t_f} \quad [\text{Eq. D-1}]$$

Where:

- k' = Conversion factor, 10^6 picocurie/microcurie (pCi/uci)
- Q_F = Cow consumption rate, 50 kg/day (R.G. 1.109)
- U_{AP} = Receptor's milk consumption rate; 330, 330, 400, 310 liters/yr for infant, child, teenager, and adult age groups, respectively (R.G. 1.109)
- Y_p = Agricultural productivity by unit area of pasture feed grass, 0.7 kg/m^2 (NUREG-0133)
- Y_s = Agricultural productivity by unit area of stored feed, 2.0 kg/m^2 (NUREG-0133)
- F_m = Stable element transfer coefficient (Table E-1, R.G. 1.109)
- r = Fraction of deposited activity retained in cow's feed grass, 0.2 for particulates, 1.0 for radioiodine (Table E-15, R.G. 1.109)
- $DFL_{i,a,o}$ = Ingestion dose factor for organ, o, and the ith radionuclide for each respective age group, a (Tables E-11 to E-14, R.G. 1.109)
- λ_i = Decay constant for the ith radionuclide, sec^{-1}
- λ_w = Decay constant for weathering, $5.73 \times 10^{-7} \text{ sec}^{-1}$ (NUREG-0133)
- t_f = $1.73 \times 10^5 \text{ sec}$, Transport time from pasture to cow to milk to receptor (Table E-15, R.G. 1.109)
- t_h = $7.78 \times 10^6 \text{ sec}$, Transport time from pasture to harvest to cow to milk to receptor (Table E-15, R.G. 1.109)
- f_p = 1.0, Fraction of the year that the cow is on pasture
- f_s = 1.0, Fraction of the cow feed that is pasture grass while the cow is on pasture

The concentration of tritium in milk is based on the airborne concentration rather than the deposition. Therefore, $R_{i,a,o}^C$ is based on (X/Q):

$$R_{t,a,o}^C = k' k''' F_m Q_F U_{AP} DFL_{t,a,o} (.75(.5/H)) \quad [\text{Eq. D-2}]$$

APPENDIX D (CONTINUED)

Where:

- k''' = 10^3 grams/kg
- H = 8 grams/m³, Absolute humidity of the atmosphere
- .75 = Fraction of total feed grass mass that is water
- .5 = Ratio of the specific activity of the feed grass water to the atmospheric water. (NUREG-0133)
- DFL_{t,a,o} = Ingestion dose factor for tritium and organ, o, for each respective age group, a (Tables E-11 to E-14, R.G. 1.109).

All other parameters and values are as given above.

NOTE: Goat-milk pathway factor, $R_{i,a,o}^C$ will be computed using the cow-milk pathway factor equation. F_m factor for goat-milk will be from Table E-2, R.G. 1.109. Q_F for goats is 6 kg/day from Table E-3, R.G. 1.109.

APPENDIX E
COW-MEAT PATHWAY DOSE FACTOR ($R_{i,a,o}^M$)

$$R_{i,a,o}^M = k' [(Q_F \times U_{AP}) / (\lambda_1 + \lambda_W)] \times (F_f) \times (r) \times (DFL_{i,a,o}) \times [((f_p \times f_s) / Y_p) + ((1 - f_p f_s) e^{-\lambda_i t_h}) / Y_s] \times e^{-\lambda_i t_f} \quad [\text{Eq. E-1}]$$

Where:

- k' = Conversion factor, 10^6 picocurie/microcurie (pCi/uCi)
- Q_F = Cow consumption rate, 50 kg/day (R.G. 1.109)
- U_{AP} = Receptor's meat consumption rate; 0, 41, 65, 110 kg/yr for infant, child, teenager, and adult age groups, respectively (R.G. 1.109)
- F_f = Stable element transfer coefficients, days/kg (Table E-1, R.G. 1.109)
- r = Fraction of deposited activity retained in cow's feed grass, 0.2 for particulates, 1.0 for radioiodine (Table E-15, R.G. 1.109)
- $DFL_{i,a,o}$ = Ingestion dose factor for organ, o, and the ith radionuclide for each respective age group, a (Tables E-11 to E-14, R.G. 1.109)
- λ_i = Decay constant for radionuclide i, sec^{-1}
- λ_w = Decay constant for weathering, $5.73 \times 10^{-7} \text{ sec}^{-1}$ (NUREG-0133)
- t_f = 1.73×10^6 sec, Transport time from pasture to receptor (NUREG-0133)
- t_h = 7.78×10^6 sec, Transport time from crop to receptor (NUREG-0133)
- Y_p = Agricultural productivity by unit area of pasture feed grass, 0.7 kg/m^2 (NUREG-0133)
- Y_s = Agricultural productivity by unit area of stored feed, 2.0 kg/m^2 (NUREG-0133)
- f_p = 1.0, Fraction of the year that the cow is on pasture
- f_s = 1.0, Fraction of the cow feed that is pasture grass while the cow is on pasture.

APPENDIX E (CONTINUED)

The concentration of tritium in meat is based on its airborne concentration rather than the deposition. Therefore $R_{t,a,o}^M$ is based on (X/Q):

$$R_{t,a,o}^M = k' k'' F_f Q_F U_{AP} (DFL_{t,a,o}) \times 0.75 \times (0.5/H) \quad [\text{Eq. E-2}]$$

Where:

All terms are as defined above and in Appendix D.

APPENDIX F
VEGETATION PATHWAY DOSE FACTOR ($R_{i,a,o}^V$)

$$R_{i,a,o}^V = k' \times [r / (Y_v(\lambda_i + \lambda_w))] \times (DFL_{i,a,o}) \times [(U_A^L f_L e^{-\lambda_i t_L} + U_A^S f_g e^{-\lambda_i t_h}] \quad [\text{Eq. F-1}]$$

Where:

- k' = 10^6 picocurie/microcurie (pCi/uCi)
- U_A^L = Consumption rate of fresh leafy vegetation, 0, 26, 42, 64 kg/yr for infant, child, teenager, or adult age groups, respectively (R.G. 1.109)
- U_A^S = Consumption rate of stored vegetation, 0, 520, 630, 520 kg/yr for infant, child, teenager, or adult age groups respectively (R.G. 1.109)
- f_L = Fraction of the annual intake of fresh leafy vegetation grown locally, 1.0 (NUREG-0133)
- f_g = Fraction of the stored vegetation grown locally .76 (NUREG-0133)
- t_L = Average time between harvest of leafy vegetation and its consumption, 8.6×10^4 seconds (Table E-15, R.G. 1.109 (24 hrs))
- t_h = Average time between harvest of stored leafy vegetation and its consumption, 5.18×10^6 seconds (Table E-15, R.G. 1.109 (60 days))
- y_v = Vegetation areal density, 2.0 kg/m^2 (Table. E-15, R.G. 1.109)

All other parameters are as previously defined.

The concentration of tritium in vegetation is based on the airborne concentration rather than the deposition. Therefore, $R_{i,a,o}^V$ is based on (X/Q)

$$R_{t,a,o}^V = k' k''' [U_A^L f_L + U_A^S f_g] (DFL_{t,a,o}) (.75 (.5/H)) \quad [\text{Eq. F-2}]$$

Where:

All terms are as defined above and in Appendix D.

APPENDIX G
SUPPLEMENTAL GUIDANCE STATEMENTS
HAVE BEEN DELETED

CPSSES/ODCM

COMANCHE PEAK STEAM ELECTRIC STATION OFFSITE DOSE CALCULATION MANUAL (ODCM) EFFECTIVE LISTING FOR SECTIONS, TABLES, AND FIGURES

BELOW IS A LEGEND FOR THE EFFECTIVE LISTING OF SECTIONS, TABLES, AND FIGURES:

Revision 0 (TXX-89118)	Submitted to the NRC March 2, 1989
Revision 1 (TXX-89595)	Submitted to the NRC August 25, 1989
Revision 2 (TXX-89711)	Submitted to the NRC November 27, 1989
Revision 3	April 10, 1990
Revision 4	October 9, 1990
Revision 5	December 20, 1990
Revision 6	July 3, 1991
Revision 7	December 4, 1991
Revision 7A	August 6, 1992
Revision 8 (Unit 2 Operations)	January 1, 1993
Revision 9	September 28, 1994
Revision 10	April 22, 1994
Revision 11	November 7, 1994
Revision 12	December 8, 1995
Revision 13	February 14, 1996
Revision 14	October 1, 1996
Revision 15	March 3, 1999
Revision 16	July 27, 1999
Revision 17	October 7, 1999
Revision 18	December 20, 1999
Revision 19	October 16, 2001
Revision 20	July 8, 2002
Revision 21	March 23, 2004
Revision 22	December 8, 2004
Revision 23	January 31, 2006
Revision 24	March 13, 2006
Revision 25	June 1, 2006
Revision 26	December 12, 2006

CPSES/ODCM

PART I

Section 1	Revision 23
Table 1.1	Revision 23
Table 1.2	Revision 23
Section 2	Revision 23
Section 3/4	Revision 26
Bases 3/4	Revision 23
Section 5	Revision 23
Figure 5.1-3	Revision 23
Section 6	Revision 23

PART II

Section 1	Revision 23
Table 1.1	Revision 23
Table 1.2	Revision 23
Figure 1.1	Revision 23
Figure 1.2	Revision 23
Figure 1.3	Revision 23
Section 2	Revision 26
Table 2.1	Revision 26
Table 2.2	Revision 23
Table 2.3	Revision 23
Table 2.4	Revision 23
Table 2.5	Revision 23
Figure 2.1	Revision 23
Figure 2.2	Revision 23
Figure 2.3	Revision 23
Figure 2.4	Revision 23
Figure 2.5	Revision 23
Section 3	Revision 23
Table 3.1	Revision 23
Figure 3.1	Revision 23
Appendix A	Revision 23
Appendix B	Revision 23
Appendix C	Revision 23
Appendix D	Revision 23
Appendix E	Revision 23
Appendix F	Revision 23
Appendix G	Revision 23

CPSES/ODCM

EL-1
EL-2
EL-3

Revision 26
Revision 26
Revision 26